

Level Measurement

Point level measurement
Vibrating switches

SITRANS LVL200

Overview



SITRANS LVL200 is a standard vibrating level switch for material detection in liquid and slurry applications such as overflow, high, low, and demand applications, as well as pump protection. For use in SIL-2 applications.

Benefits

- Proven vibrating level switch technology for liquids
- Compact insertion length of 40 mm (1.57 inch) for confined space applications
- Fault monitoring for corrosion, loss of vibration or line break to the piezo drive
- Functional Safety (SIL 2). Device suitable for use in accordance with IEC 61508 and IEC 61511
- Hygienic process connections
- Suitable for API 2350
- Optional remote test signal conditioner

Application

SITRANS LVL200 is a level switch designed for industrial use in all areas of process technology and can be used with liquids and slurries. With a tuning fork insertion length of only 40 mm (1.57 inch), SITRANS LVL200 can be mounted in small pipes and applications with confined space. The LVL200 can be used to measure products with a minimum density of $> 0.5 \text{ g/cm}^3$ (0.018 lb/in^3). The LVL200 can be used in difficult conditions including turbulence, air bubbles, foam generation, buildup, or external vibration.

SITRANS LVL200 continuously monitors faults via frequency evaluation, providing early detection of strong corrosion or damage on the tuning fork, loss of vibration, or a line break to the piezo drive.

The tuning fork is piezoelectrically energized and vibrates at its mechanical resonance frequency of approximately 1 200 Hz. The vibration frequency changes when the tuning fork is covered by the medium. This change is detected by the integrated oscillator and converted into a switching command. The integrated electronics evaluate the level signal and output a switching signal, directly operating connected devices.

The optional signal conditioner provides a remote test feature to ensure continuous product reliability.

- Key Applications: for use in liquids and slurries, for level measurement, overflow, and dry run protection

Configuration

Horizontal mounting

Marked with screwed version on top, with flange versions directed to the flange holes

Switching point (recommended mounting position, particularly for adhesive applications)

Vertical mounting

Switching point with lower density

Switching point [approx. 13 (0.51)]

Switching point with higher density

Switching point [approx. 27 (1.06)]

Mount away from filling openings or agitators.

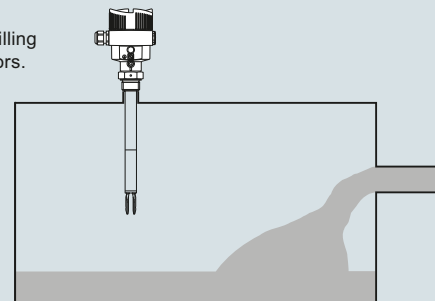

Moisture protection

NOTE:
Welded socket for flush mount optional

Ensure cable gland faces downward to avoid water ingress.

SITRANS LVL200 installation, dimensions in mm (inch)

Technical specifications

Mode of operation		Design	
Measuring principle	Vibrating point level switch	Material	<ul style="list-style-type: none"> Aluminum die-cast AlSi10Mg, powder-coated, basis: Polyester Stainless steel housing, electropolished 316L Stainless steel housing, precision casting 316L Plastic housing, plastic PBT (Polyester)
Input		• Enclosure	
Measured variable	High and low and demand (via mode switch)	• Tuning fork	316L (1.4404 or 1.4435), Alloy C22
Output		• Extension tube [ø 21.3 mm (0.839 inch)]	316L (1.4404 or 1.4435), Alloy C22
Output options	<ul style="list-style-type: none"> Relay output (DPDT), 2 floating SPDTs Contactless electronic switch 2-wire Namur signal output Transistor (NPN/PNP) 10 ... 55 V DC 8/16 mA 	• Process connection: threaded	<ul style="list-style-type: none"> Standard, Extended: 316L (1.4404 or 1.4435), Alloy C22 High temperature: Inconel 718
Measuring accuracy		• Process connection: flange	<ul style="list-style-type: none"> Standard, Extended: 316L (1.4404 or 1.4435), 316L with Alloy C22, ECTFE, or PFA coating Klingsil C-4400
Repeatability	0.1 mm (0.004 inch)	• Process seal	
Hysteresis	Approx. 2 mm (0.08 inch) with vertical installation	Process connection	
Switching delay	<ul style="list-style-type: none"> Standard, Extended: approx. 500 ms (on/off) High temperature: approx. 1 s (optionally adjustable at factory) 	• Pipe thread, cylindrical (ISO 228 T1)	G ¾" A, G 1" A
Frequency	<ul style="list-style-type: none"> Standard, Extended: Approx. 1 200 Hz High temperature: 1400 Hz 	• Pipe thread, tapered	¾" NPT, 1" NPT, 1½" NPT
Rated operating conditions		• Flanges	DIN from DN 25, ASME from 1"
Installation conditions		• Hygienic fittings	Bolting DN 40 PN 40, 1, 1½, 2, 2½" Tri-Clamp PN 10, conus DN 25 PN 40, Tuohenhagen Varivent DN 50 PN 10, SMS
• Location	Indoor/outdoor	Degree of protection	Type 4X/NEMA 4X/IP66/IP67
Ambient conditions		Conduit entry	<ul style="list-style-type: none"> 1 x M20 x 1.5 (cable: ø 5 ... 9 mm), 1 x blind stopper M20 x 1.5; attached 1 x M20 x 1.5 cable entry 1 x ½" NPT cable entry, 1 x blind stopper ½" NPT, 1 x ½" NPT cable entry 1 x M12 x 1; 1 x blind stopper M20 x 1.5
• Ambient temperature	-40 ... +70 °C (-40 ... +158 °F)	Weight	
• Installation category	III	• Device weight (dependent on process fitting)	Approx. 0.8 ... 4 kg (0.18 ... 8.82 lb)
• Pollution degree	2	• Tube extension (extended version)	Approx. 920 g/m (10 oz/ft)
Medium conditions		Power supply	
• Temperature		Supply voltage	20 ... 253 V AC, 50/60 Hz,
- LVL200S Standard	-50 ... +150 °C (-58 ... +302 °F)	• Relay DPDT	20 ... 72 V DC [at U > 60 V DC]
- LVL200S High temperature option	-50 ... +250 °C (-58 ... +482 °F)	• Contactless	20 ... 253 V AC, 50/60 Hz,
- LVL200E Standard: with 316L/Alloy C22	-50 ... +150 °C (-58 ... +302 °F)	• 2-wire NAMUR	20 ... 253 V DC
- LVL200E High temperature option with 316L/Alloy C22	-50 ... +250 °C (-58 ... +482 °F)	Operating voltage (characteristics according to standard) for connection to an amplifier according to NAMUR	IEC 60947-5-6, approx. 8.2 V Off-load voltage U ₀ approx. 8.2 V Short-circuit current I _U approx. 8.2 mA
- LVL200H, High temperature	-196 ... +450 °C (-321 ... +842 °F)	Operating voltage 8/16 mA (via the signal conditioning instrument)	
Pressure (vessel)	<ul style="list-style-type: none"> Standard, Extended: -1 ... 64 bar g (-14.5 ... 928 psi g) High temperature: instrument version up to 160 bar (2 320 psi g): -1 ... 160 bar/-100 ... 16 000 kPa (-14.5 ... 2 320 psi g) <p>Note: The process pressure is dependent on configuration, including process fitting, e.g. flange</p>	• Non-Ex instrument	12 ... 36 V DC
Density	0.7 ... 2.5 g/cm ³ (0.025 ... 0.09 lb/in ³); 0.5 ... 2.5 g/cm ³ (0.018 ... 0.09 lb/in ³) by switching over Density optionally starts at 0.47 cm ³ (0.017 lb/in ³)	• Ex-d instrument (ATEX, FM, CSA)	12 ... 36 V DC
		• Ex-ia instrument (ATEX)	12 ... 29 V DC
		• Ex-ia instrument (FM, CSA)	12 ... 31 V DC

Level Measurement

Point level measurement

Vibrating switches

SITRANS LVL200

<p>Power consumption</p> <ul style="list-style-type: none"> • Relay DPDT • Contactless <p>• 8/16 mA, two-wire output</p> <p>• 2-wire Namur</p> <p>• Transistor (NPN/PNP) 10 ... 55 V DC</p>	<ul style="list-style-type: none"> • Standard, Extended: 1 ... 8 VA (AC), approx. 1.3 W (DC) • High temperature: 3 VA (AC), 1 W (DC) <p>1 ... 8 VA (AC), approx. 1.3 W (DC)</p> <p>Domestic current requirement approx. 3 mA (via load circuit)</p> <p>Load current</p> <ul style="list-style-type: none"> • Min. 10 mA • Max. 400 mA [with I > 300 mA the ambient temperature can be max. 60 °C (140 °F)] • Max. 4 A up to 40 ms (not WHG specified) <p>Output signal</p> <ul style="list-style-type: none"> • Empty (uncovered) <ul style="list-style-type: none"> - 8 mA • Full (covered) <ul style="list-style-type: none"> - 16 mA • Fault message <ul style="list-style-type: none"> - < 1.8 mA <p>Possible signal conditioning instruments: SITRANS SCSC, SITRANS TCSC</p> <p>Current consumption</p> <ul style="list-style-type: none"> • Falling characteristics ≥ 2.6 mA uncovered/≤ 0.6 mA covered • ≤ 0.6 mA uncovered/≥ 2.6 mA covered • Failure message ≤ 0.6 mA <p>Output</p> <ul style="list-style-type: none"> • Floating transistor output, permanently shortcircuit-proof <p>Load current</p> <ul style="list-style-type: none"> • < 400 mA <p>Voltage loss</p> <ul style="list-style-type: none"> • < 1 V <p>Switching voltage</p> <ul style="list-style-type: none"> • < 55 V DC <p>Blocking current</p> <ul style="list-style-type: none"> • < 10 μA
<p>Certificates and approvals</p>	<ul style="list-style-type: none"> • CE, CSA • Overfill Protection WHG and VLAREM II • FM (Non-Incendive) Class I, Div. 2, Groups A, B, C, D • FM (Explosion-Proof) Class I, Div. 1, Groups A, B, C, D; (Dust Ignition-Proof) Class II, III, Div. 1, Groups E, F, G1 • IECEx d IIC T6 ... T2 Ga/Gb EHEDG • ATEX II 1/2G, 2G EEx d IIC T6 • ATEX II 1G, 1/2G, 2G EEx ia IIC T6 • Shipping approvals • BR-Ex d IIC T6 ... T2 • FDA, 3A, EHEDG • SIL/IEC61508 Declaration of Conformity [SIL-2 (min/max detection)] <p>Please see configuration section below for full list of approvals.</p>

Selection and Ordering data	Article No.
SITRANS LVL200, Standard Compact vibrating level switch for material detection in liquid and slurry applications such as overflow, high, low, and demand applications, as well as pump protection. For use in SIL-2 and hazardous applications. ➤ Click on the Article No. for the online configuration in the PIA Life Cycle Portal.	7ML5746-
Electronics Contactless electronic switch 20 ... 250 V AC/DC ¹⁾⁹⁾²⁴⁾ Double relay (DPDT) 20 ... 72 V DC/ 20 ... 250 V AC ²⁴⁾ NAMUR signal ⁹⁾ Transistor (NPN/PNP) 10 ... 55 V DC ¹⁾²⁵⁾ Two-wire (8/16 mA) 12 ... 36 V DC	1 2 4 5 6
Approvals Without approvals Overfill protection (WHG) ⁹⁾ ATEX II 1G, 1/2G, 2G Ex ia IIC T6 + WHG ⁶⁾⁹⁾ ATEX II 1/2G, 2G Ex d IIC T6 + WHG ⁵⁾¹⁵⁾ ATEX II 1G, 1/2G, 2G Ex ia IIC T6 + shipping approvals ⁶⁾¹⁶⁾ ATEX II 1/2G, 2G Ex d IIC T6 + shipping approvals ⁵⁾¹⁵⁾ ATEX II 1G, 1/2G, 2G Ex ia IIC T6 + ATEX II 1/2 D IP6X T ⁶⁾⁷⁾¹⁷⁾ IECEX Ex ia IIC T6 ⁶⁾¹⁸⁾ Shipping approvals ¹⁶⁾ ATEX II 3G Ex nA II T5 ... T1 X ¹⁴⁾¹⁹⁾ FM (IS) Class I, II, III, Div. 1, Groups A, B, C, D, E, F, G ⁶⁾²⁰⁾ FM (XP) Class I, Div. 1, Groups A, B, C, D; (DIP) Class II, III, Div. 1, Groups E, F, G ²⁾⁵⁾¹⁰⁾ FM (NI) Class I, Div. 2, Groups A, B, C, D ²⁾¹⁾ IECEX d IIC T6 ... T2 Ga/Gb ⁵⁾¹⁵⁾ CSA (XP) Class I, II, III Div. 1, Groups A, B, C, D, E, F, G ⁵⁾¹⁵⁾ CSA(NI) Class I, II, III, Div. 2, Groups A, B, C, D, E, F, G ²⁾²⁾ BR-Ex d IIC T6 ... T2 ⁵⁾²³⁾ CSA (IS) Class I, II, III Div. 1, Groups A, B, C, D, E, F, G ⁶⁾⁹⁾ ATEX II 1G, 1/2G, 2G Ex ia IIC T6 ⁶⁾	A B C D E F G H K L N P Q R S T U V W
Process connection Thread G ³ / ₄ " A, PN 64/316L Thread G ³ / ₄ " A, PN 64/316L Ra < 0.8 µm Thread ³ / ₄ " NPT, PN 64/316L Thread ³ / ₄ " NPT, PN 64/316L Ra < 0.8 µm Thread ³ / ₄ " NPT, PN 64/Alloy 400 (2.4360) Thread G ³ / ₄ " A, PN 64/Alloy C22 (2.4602) Thread ³ / ₄ " NPT, PN 64/Alloy C22 (2.4602) Thread G1" A, PN 64/316L Thread G1" A, PN 64/316L ECTFE coated MB1982 ⁴⁾ Thread G1" A, PN 64/ 316L PFA coated ⁴⁾ Thread G1" A, PN 64/ Alloy 400 (2.4360) Thread G1" A, PN 64/ 316L Ra < 0.8 µm Thread 1" NPT, PN 64/ 316L Thread 1" NPT, PN 64/ 316L ECTFE coated MB1982 ⁴⁾ Thread 1" NPT, PN 64 / 316L PFA-coated ⁴⁾ Thread 1" NPT, PN 64 / Alloy 400 (2.4360) Thread 1" NPT, PN 64 / 316L Ra < 0.8 µm Thread G1" A, PN 64 / Alloy C22 (2.4602) Thread G1" A, PN 64/Alloy C22 (2.4602) Ra < 0.3 µm Thread G1 ¹ / ₂ " A, PN 64/316L Thread G1 ¹ / ₂ " A, PN 64/316L Ra < 0.8 µm Thread G1 ¹ / ₂ " A, PN 64/Alloy C22 (2.4602)	A 0 0 A 0 1 A 0 2 A 0 3 A 0 4 A 0 5 A 0 6 A 0 7 A 0 8 A 1 0 A 1 1 A 1 2 A 1 3 A 1 4 A 1 5 A 1 6 A 1 7 A 1 8 A 2 0 A 2 1 A 2 2 A 2 3

Selection and Ordering data	Article No.
SITRANS LVL200, Standard Compact vibrating level switch for material detection in liquid and slurry applications such as overflow, high, low, and demand applications, as well as pump protection. For use in SIL-2 and hazardous applications.	7ML5746-
Thread 1" NPT, PN 64/Alloy C22 (2.4602) Thread 1 ¹ / ₂ " NPT, PN 64/316L Thread 1 ¹ / ₂ " NPT, PN 64/316L Ra < 0.8 µm Thread 1 ¹ / ₂ " NPT, PN 64/Alloy C22 (2.4602) Thread G2" A, PN 64/316L Thread M27 x 1.5, PN 64/316L Conus DN 25, PN 40/316L Ra < 0.3 µm Conus DN 25, PN 40/316L Ra < 0.8 µm Conus DN 25, PN 40/ECTFE (ZB3033) ⁴⁾ Conus M52, PN 40/316L Conus M52, PN 40/316L Ra < 0.3 µm Conus M52, PN 40/316L Ra < 0.8 µm Tri-Clamp 1", PN 16/316L Ra < 0.3 µm Tri-Clamp 1", PN 16/Alloy C22 (2.4602) Tri-Clamp 1", PN 16/316L Ra < 0.8 µm Tri-Clamp 1 ¹ / ₂ ", PN 16/316L Ra < 0.3 µm Tri-Clamp 1 ¹ / ₂ ", PN 16/Alloy C22 (2.4602) Tri-Clamp 1 ¹ / ₂ ", PN 16/316L Ra < 0.8 µm Tri-Clamp 2", PN 16/316L Ra < 0.3 µm Tri-Clamp 2", PN 16/Alloy C22 (2.4602) Tri-Clamp 2", PN 16/316L Ra < 0.8 µm Tri-Clamp 2 ¹ / ₂ ", PN 10/316L Ra < 0.3 µm Tri-Clamp 2 ¹ / ₂ ", PN 10/316L Ra < 0.8 µm Tri-Clamp 3", PN 10/316L Ra < 0.3 µm Tri-Clamp 3", PN 10/316L Ra < 0.8 µm Bolting DN 32, PN 40 DIN11851/316L Ra < 0.3 µm Bolting DN 32, PN 40 DIN11851/316L Ra < 0.8 µm Bolting DN 25, PN 40 DIN11851/316L Ra < 0.3 µm Bolting DN 25, PN 40 DIN11851/316L Ra < 0.8 µm Bolting DN 40, PN 40 DIN11851/316L Ra < 0.3 µm Bolting DN 40, PN 40 DIN11851/316L Ra < 0.8 µm Bolting DN 40, PN 40 DIN11864-1 A/316L Ra < 0.8 µm ZB3052 Bolting DN 50, PN 25 DIN11851/316L Ra < 0.3 µm Bolting DN 50, PN 25 DIN11851/316L Ra < 0.8 µm Bolting DN 50, PN 25 DIN11864-1 A/316L Ra < 0.8 µm ZB3052 Hygienic w. compr. nut F40, PN 25/316L Hygienic w. compr. nut F40, PN 25/316L Ra < 0.3 µm Hygienic w. compr. nut F40, PN 25/316L Ra < 0.8 µm Varivent N50-40/316L Ra < 0.3 µm Varivent N50-40/316L Ra < 0.8 µm Varivent N125/100/316L Ra < 0.8 µm DRD flange, PN 40/316L ZB3007 SMS DN 38/316L Ra < 0.8 µm ⁴⁾ SMS DN 51, PN 6/316L Ra < 0.8 µm ⁴⁾ Swagelok VCR screwing ZG2579, PN 64/316L Neumo biocontrol size 25, PN 16/316L Ra < 0.8 µm Neumo biocontrol size 50, PN 16/316L Ra < 0.8 µm ⁴⁾ Neumo biocontrol size 65, PN 16/316L Ra < 0.8 µm Neumo biocontrol size 80, PN 16/316L Ra < 0.8 µm SÜDMO DN 50, PN 10/316L Ra < 0.8 µm Small flange DN 25, PN 1.5 DIN 28403/316L pol. Ra < 0.8 µm Small flange DN 40, PN 1.5 DIN 28403/316L pol. Ra < 0.8 µm Ingold connection, PN16 / 316 L Ra < 0.8 µm (acc. to MB2523)	A 2 4 A 2 5 A 2 6 A 2 7 A 2 8 A 3 0 A 3 1 A 3 2 A 3 3 A 3 4 A 3 5 A 3 6 A 3 7 A 3 8 A 4 0 A 4 1 A 4 2 A 4 3 A 4 4 A 4 5 A 4 6 A 4 7 A 4 8 A 5 0 A 5 1 A 5 2 A 5 3 A 5 4 A 5 5 A 5 6 A 5 7 A 5 8 A 6 0 A 6 1 A 6 2 A 6 3 A 6 4 A 6 5 A 6 6 A 6 7 A 6 8 A 7 0 A 7 1 A 7 2 A 7 3 A 7 4 A 7 5 A 7 6 A 7 7 A 7 8 A 8 0 A 8 1 A 8 2

Level Measurement

Point level measurement

Vibrating switches

SITRANS LVL200

Selection and Ordering data

Article No.

SITRANS LVL200, Standard

Compact vibrating level switch for material detection in liquid and slurry applications such as overflow, high, low, and demand applications, as well as pump protection. For use in SIL-2 and hazardous applications.

	7ML5746- A 0
Ingold connection, PN 16/Alloy C22 (2.4602) Ra < 0.8 µm (acc. to MB6017)	A 8 3
Terminal DN 33.7 PN 40 DIN11864-3-A-/316L BN2 Ra < 0.8 µm ⁴⁾	A 8 4
Hygienic fl. DN 50 PN 16 DIN11864-2-A-/316L Ra < 0.8 µm	A 8 5
Flange DN 25, PN 6 Form C, DIN 2501/316L	A 8 6
Flange DN 25, PN 6 Form C, DIN 2501/PFA ⁴⁾	A 8 7
Flange DN 25, PN 40 Form C, DIN 2501/316L	A 8 8
Flange DN 25, PN 40 Form C, DIN 2501/ Alloy C22 (2.4602)	B 0 0
Flange DN 25, PN 40 Form C, DIN 2501/ECTFE ⁴⁾	B 0 1
Flange DN 25, PN 40 Form C, DIN 2501/PFA ⁴⁾	B 0 2
Flange DN 25, PN 40 Form C, DIN 2501/Enamelled ³⁾	B 0 3
Flange DN 25, PN 40 Form D, DIN 2501/316L	B 0 4
Flange DN 25, PN 40 Form F, DIN 2501/316L	B 0 5
Flange DN 25, PN 40 Form N, DIN 2501/316L	B 0 6
Flange DN 25, PN 40 Form N, DIN 2501/ Alloy C22 (2.4602)	B 0 7
Flange DN 25, PN 40 Form N, DIN 2501/ Alloy 400 (2.4360) solid	B 0 8
Flange DN 25, PN 40 V13, DIN 2501/316L	B 1 0
Flange DN 32, PN 40 Form C, DIN 2501/316L	B 1 1
Flange DN 32, PN 40 Form C, DIN 2501/ECTFE ⁴⁾	B 1 2
Flange DN 40, PN 6 Form C, DIN 2501/316L	B 1 3
Flange DN 40, PN 6 Form C, DIN 2501/ECTFE ⁴⁾	B 1 4
Flange DN 40, PN 40 Form C, DIN 2501/316L	B 1 5
Flange DN 40, PN 40 Form C, DIN 2501/ Alloy C22 (2.4602)	B 1 6
Flange DN 40, PN 40 Form C, DIN 2501/ECTFE ⁴⁾	B 1 7
Flange DN 40, PN 40 Form C, DIN 2501/PFA ⁴⁾	B 1 8
Flange DN 40, PN 40 Form C, DIN 2501/ Enamelled ³⁾	B 2 0
Flange DN 40, PN 40 Form F, DIN 2501/316L	B 2 1
Flange DN 40, PN 40 Form N, DIN 2501/316L	B 2 2
Flange DN 40, PN 40 Form E, DIN 2501/316L	B 2 3
Flange DN 40, PN 40 V13, DIN 2501/316L	B 2 4
Flange DN 50, PN 40 Form C, DIN 2501/316L	B 2 5
Flange DN 50, PN 40 Form C, DIN 2501/ Alloy C22 (2.4602)	B 2 6
Flange DN 50, PN 40 Form C, DIN 2501/ECTFE ⁴⁾	B 2 7
Flange DN 50, PN 40 Form C, DIN 2501/ ECTFE (ZB3108) ⁴⁾	B 2 8
Flange DN 50, PN 40 Form C, DIN 2501/PFA ⁴⁾	B 3 0
Flange DN 50, PN 40 Form D, DIN 2501/316L	B 3 1
Flange DN 50, PN 40 Form D, DIN 2501/ Alloy C22 (2.4602)	B 3 2
Flange DN 50, PN 40 Form F, DIN 2501/316L	B 3 3
Flange DN 50, PN 40 Form N, DIN 2501/316L	B 3 4
Flange DN 50, PN 40 Form N, DIN 2501/ Alloy C22 (2.4602)	B 3 5
Flange DN 50, PN 40 Form E, DIN 2501/316L	B 3 6
Flange DN 50, PN 40 V13, DIN 2501/316L	B 3 7
Flange DN 50, PN 40 R13, DIN 2501/316L	B 3 8
Flange DN 50, PN 64 Form F, DIN 2501/316L	B 4 0
Flange DN 50, PN 64 Form N, DIN 2501/ Alloy C22 (2.4602)	B 4 1
Flange DN 50, PN 64 Form C, DIN 2501/316L	B 4 2
Flange DN 50, PN 64 Form L, DIN 2501/316L	B 4 3
Flange DN 50, PN 100 Form E, DIN 2501/316L	B 4 4
Flange DN 50, PN 100 Form L, DIN 2501/316L	B 4 5
Flange DN 65, PN 40 Form C, DIN 2501/316L	B 4 6

Selection and Ordering data

Article No.

SITRANS LVL200, Standard

Compact vibrating level switch for material detection in liquid and slurry applications such as overflow, high, low, and demand applications, as well as pump protection. For use in SIL-2 and hazardous applications.

	7ML5746- A 0
Flange DN 65, PN 40 Form C, DIN 2501/ Alloy C22 (2.4602)	B 4 7
Flange DN 65, PN 40 Form C, DIN 2501/ECTFE ⁴⁾	B 4 8
Flange DN 65, PN 40 Form C, DIN 2501/PFA ⁴⁾	B 5 0
Flange DN 65, PN 40 Form F, DIN 2501/316L	B 5 1
Flange DN 65, PN 64 Form E, DIN 2501/316L	B 5 2
Flange DN 80, PN 40 Form C, DIN 2501/316L	B 5 3
Flange DN 80, PN 40 Form C, DIN 2501/ Alloy C22 (2.4602)	B 5 4
Flange DN 80, PN 40 Form C, DIN 2501/ECTFE ⁴⁾	B 5 5
Flange DN 80, PN 40 Form C, DIN 2501/PFA ⁴⁾	B 5 6
Flange DN 80, PN 40 Form C, DIN 2501/ Enamelled ³⁾	B 5 7
Flange DN 80, PN 40 Form F, DIN 2501/316L	B 5 8
Flange DN 80, PN 40 Form N, DIN 2501/316L	B 6 0
Flange DN 100, PN 16 Form C, DIN 2501/316L	B 6 2
Flange DN 100, PN 16 Form C, DIN 2501/ Alloy C22 (2.4602)	B 6 3
Flange DN 100, PN 16 Form C, DIN 2501/ECTFE ⁴⁾	B 6 4
Flange DN 100, PN 16 Form C, DIN 2501/PFA ⁴⁾	B 6 5
Flange DN 100, PN 16 Form C, DIN 2501/ Enamelled ³⁾	B 6 6
Flange DN 100, PN 16 Form D, DIN 2501/316L	B 6 7
Flange DN 100, PN 16 Form F, DIN 2501/316L	B 6 8
Flange DN 100, PN 16 Form N, DIN 2501/316L	B 7 0
Flange DN 100, PN 40 Form C, DIN 2501/316L	B 7 1
Flange DN 100, PN 40 Form C, DIN 2501/ECTFE ⁴⁾	B 7 2
Flange DN 100, PN 40 Form C, DIN 2501/PFA ⁴⁾	B 7 3
Flange DN 100, PN 40 Form C, DIN 2501/ Enamelled ³⁾	B 7 4
Flange DN 100, PN 40 Form F, DIN 2501/316L	B 7 5
Flange DN 100, PN 40 Form N, DIN 2501/316L	B 7 6
Flange DN 100, PN 40 V13, DIN 2501/316L	B 7 7
Flange DN 100, PN 64 Form E, DIN 2501/316L	B 7 8
Flange DN 100, PN 100 Form E, DIN 2501/316L	B 8 0
Flange DN 100, PN 100 Form L, DIN 2501/316L	B 8 1
Flange DN 125, PN 16 Form F, DIN 2501/316L	B 8 2
Flange DN 125, PN 40 Form C, DIN 2501/316L	B 8 3
Flange DN 125, PN 40 Form N, DIN 2512/ 316L	B 8 4
Flange DN 150, PN 16 Form C, DIN 2501/316L	B 8 5
Flange DN 150, PN 16 Form C, DIN 2501/ Alloy C22 (2.4602)	B 8 6
Flange DN 150, PN 16 Form C, DIN 2501/ECTFE ⁴⁾	B 8 7
Flange DN 150, PN 16 Form C, DIN 2501/PFA ⁴⁾	B 8 8
Flange DN 150, PN 16 Form D, DIN 2501/316L	C 0 0
Flange DN 150, PN 40 Form C, DIN 2501/316L	C 0 1
Flange DN 150, PN 40 Form C, DIN 2501/ Alloy C22 (2.4602)	C 0 2
Flange DN 150, PN 40 Form F, DIN 2501/316L	C 0 3
Flange DN 150, PN 40 Form N, DIN 2512/316L	C 0 4
Flange DN 200, PN 10 Form C, DIN 2501/ECTFE ⁴⁾	C 0 5
Flange DN 200, PN 16 Form C, DIN 2501/316L	C 0 6
Flange DN 25, PN 40 Form B1, EN 1092-1/316L	C 0 7
Flange DN 25, PN 40 Form B1, EN 1092-1/ Alloy C22 (2.4602)	C 0 8
Flange DN 25, PN 40 Form B1, EN/ 316L/ PFA ⁴⁾	C 1 0
Flange DN 25, PN 40 Form B1, EN 1092-1/ Enamelled ³⁾	C 1 1
Flange DN 25, PN 40 Form B2, EN 1092-1/316L	C 1 2
Flange DN 25, PN 40 Form F, EN 1092-1/316L	C 1 3
Flange DN 25, PN 63 Form B1, EN 1092-1/316L	C 1 4

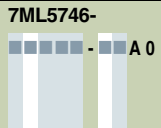
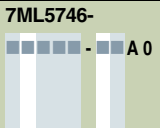
Selection and Ordering data	Article No.	Selection and Ordering data	Article No.
SITRANS LVL200, Standard Compact vibrating level switch for material detection in liquid and slurry applications such as overflow, high, low, and demand applications, as well as pump protection. For use in SIL-2 and hazardous applications.	7ML5746- 	SITRANS LVL200, Standard Compact vibrating level switch for material detection in liquid and slurry applications such as overflow, high, low, and demand applications, as well as pump protection. For use in SIL-2 and hazardous applications.	7ML5746- 
Flange DN 25, PN 100 Form B2, EN 1092-1/316L	C 15	Flange 1½" 300 lb RF, ASME B16.5/ Alloy 400 (2.4360) ZB2977	C 68
Flange DN 40, PN 40 Form B1, EN/ 316L	C 16	Flange 1½" 300 lb RF, ASME B16.5/ECTFE ³⁾	C 70
Flange DN 40, PN 40 Form B1, EN 1092-1/PFA ⁴⁾	C 17	Flange 1½" 600 lb RF, ASME B16.5/316L	C 71
Flange DN 40, PN 40 Form B2, EN/316L	C 18	Flange 2" 150 lb RF, ASME B16.5/316L	C 72
Flange DN 50, PN 40 Form B1, EN/316L	C 20	Flange 2" 150 lb RF, ASME B16.5/Alloy C22 (2.4602)	C 73
Flange DN 50, PN 40 Form B1, EN 1092-1/ Alloy C22 (2.4602)	C 21	Flange 2" 150 lb RF, ASME B16.5/Alloy 400 (2.4360) ZB2977	C 74
Flange DN 50, PN 40 Form B1, EN 1092-1/ Alloy 400 (2.4360) ZB2977	C 22	Flange 2" 150 lb RF, ASME B16.5/ECTFE ⁴⁾	C 75
Flange DN 50, PN 40 Form B1, EN 1092-1/ECTFE ⁴⁾	C 23	Flange 2" 150 lb RF, ASME B16.5/PFA ⁴⁾	C 76
Flange DN 50, PN 40 Form B1, EN/ 316L/PFA ⁴⁾	C 24	Flange 2" 150 lb RF, ASME B16.5/Enamelled ³⁾	C 77
Flange DN 50, PN 40 Form B1, EN 1092-1/ Enamelled ³⁾	C 25	Flange 2" 150 lb FF, ASME B16.5/316L	C 78
Flange DN 50, PN 40 Form C, EN 1092-1/316L	C 26	Flange 2" 150 lb FF, ASME B16.5/ECTFE ⁴⁾	C 80
Flange DN 50, PN 40 Form D, EN/316L	C 27	Flange 2" 150 lb SG (small groove), ASME B16.5/316L	C 81
Flange DN 50, PN 40 Form D, EN 1092-1/ Alloy C22 (2.4602)	C 28	Flange 2" 300 lb RF, ASME B16.5/316L	C 82
Flange DN 50, PN 40 Form B2, EN 1092-1/316L	C 30	Flange 2" 300 lb RF, ASME B16.5/Alloy C22 (2.4602)	C 83
Flange DN 50, PN 40 Form E, EN 1092-1/316L	C 31	Flange 2" 300 lb RF, ASME B16.5/ECTFE ⁴⁾	C 85
Flange DN 80, PN 40 Form B1, EN 1092-1/316L	C 32	Flange 2" 300 lb RF, ASME B16.5/PFA ⁴⁾	C 86
Flange DN 80, PN 40 Form B1, EN 1092-1/ Alloy C22 (2.4602)	C 33	Flange 2" 300 lb RF, ASME B16.5 Enamelled ³⁾	C 87
Flange DN 80, PN 40 Form B1, EN 1092-1/ECTFE ⁴⁾	C 34	Flange 2" 300 lb RJF, ASME B16.5/316L	C 88
Flange DN 80, PN 40 Form B1, EN 1092-1/ Enamelled ³⁾	C 35	Flange 2" 300 lb ST, ASME B16.5/316L	D 00
Flange DN 80, PN 40 Form B2, EN 1092-1/316L	C 36	Flange 2" 300 lb LG (large groove), ASME B16.5/316L	D 01
Flange DN 100, PN 16 Form B1, EN 1092-1/316L	C 37	Flange 2" 300 lb LT, ASME B16.5/316L	D 02
Flange DN 100, PN 16 Form B1, EN 1092-1/ Alloy C22 (2.4602)	C 38	Flange 2" 600 lb RF, ASME B16.5/316L	D 03
Flange DN 100, PN 16 Form B1, EN 1092-1/ Enamelled ³⁾	C 40	Flange 2" 600 lb RF, ASME B16.5/Alloy 400 (2.4360) ZB2977	D 04
Flange DN 100, PN 40 Form B1, EN 1092-1/316L	C 41	Flange 2" 600 lb RF, ASME B16.5/ECTFE ⁴⁾	D 05
Flange DN 100, PN 40 Form B1, EN 1092-1/ Enamelled ³⁾	C 42	Flange 2" 600 lb RJF, ASME B16.5/316L	D 06
Flange DN 100, PN 40 Form C, EN 1092-1/316L	C 43	Flange 2" 600 lb LG, ASME B16.5/316L	D 07
Flange DN 100, PN 63 Form B2, EN 1092-1/316L	C 44	Flange 2" 900 lb RJF, ASME B16.5/316L	D 08
Flange DN 150, PN 16 Form B1, EN 1092-1/316L	C 45	Flange 2½" 150 lb RF, ASME B16.5/316L	D 10
Flange DN 150, PN 16 Form B1, EN 1092-1/PFA ⁴⁾	C 46	Flange 2½" 300 lb RF, ASME B16.5/316L	D 11
Flange DN 150, PN 40 Form B1, EN 1092-1/316L	C 47	Flange 3" 150 lb RF, ASME B16.5/316L	D 12
Flange DN 150, PN 40 Form B1, EN 1092-1/ECTFE ⁴⁾	C 48	Flange 3" 150 lb RF, ASME B16.5/Alloy C22 (2.4602)	D 13
Flange DN 150, PN 40 Form B2, EN 1092-1/316L	C 50	Flange 3" 150 lb RF, ASME B16.5/ECTFE ⁴⁾	D 14
Flange 1" 150 lb ASME B16.5/316L	C 51	Flange 3" 150 lb RF, ASME B16.5/PFA ⁴⁾	D 15
Flange 1" 150 lb RF, ASME B16.5/Alloy C22 (2.4602)	C 52	Flange 3" 150 lb RF, ASME B16.5/Enamelled ³⁾	D 16
Flange 1" 150 lb RF, ASME B16.5/Alloy 400 (2.4360) ZB2977	C 53	Flange 3" 150 lb FF, ASME B16.5/316L	D 17
Flange 1" 150 lb RF, ASME B16.5/ECTFE ⁴⁾	C 54	Flange 3" 150 lb FF, ASME B16.5/ECTFE ⁴⁾	D 18
Flange 1" 150 lb RF, ASME B16.5/PFA ⁴⁾	C 55	Flange 3" 150 lb FF, ASME B16.5/PFA ⁴⁾	D 20
Flange 1" 150 lb RF, ASME B16.5/Enamelled ³⁾	C 56	Flange 3" 300 lb RF, ASME B16.5/316L	D 21
Flange 1" 300 lb RF, ASME B16.5/316L	C 57	Flange 3" 300 lb RF, ASME B16.5/Alloy C22 (2.4602)	D 22
Flange 1" 300 lb RF, ASME B16.5/ECTFE ⁴⁾	C 58	Flange 3" 300 lb RF, ASME B16.5/ECTFE ⁴⁾	D 23
Flange 1" 600 lb RF, ASME B16.5/316L	C 60	Flange 3" 300 lb RF, ASME B16.5/PFA ⁴⁾	D 24
Flange 1½" 150 lb RF, ASME B16.5/316L	C 61	Flange 3" 300 lb RF, ASME B16.5/Enamelled ³⁾	D 25
Flange 1½" 150 lb RF, ASME B16.5/ Alloy C22 (2.4602)	C 62	Flange 3" 600 lb RF, ASME B16.5/316L	D 26
Flange 1½" 150 lb RF, ASME B16.5/ECTFE ⁴⁾	C 63	Flange 3½" 150 lb RF, ASME B16.5/316L	D 27
Flange 1½" 150 lb RF, ASME B16.5/PFA ⁴⁾	C 64	Flange 3½" 150 lb RF, ASME B16.5/ECTFE ⁴⁾	D 28
Flange 1½" 150 lb RF, ASME B16.5 Enamelled ³⁾	C 65	Flange 4" 150 lb RF, ASME B16.5/316L	D 30
Flange 1½" 150 lb FF, ASME B16.5/ECTFE ⁴⁾	C 66	Flange 4" 150 lb RF, ASME B16.5/Alloy C22 (2.4602)	D 31
Flange 1½" 300 lb RF, ASME B16.5/316L	C 67	Flange 4" 150 lb RF, ASME B16.5/ECTFE ⁴⁾	D 32
		Flange 4" 150 lb RF, ASME B16.5/PFA ⁴⁾	D 33
		Flange 4" 150 lb RF, ASME B16.5/Enamelled ³⁾	D 34

Level Measurement

Point level measurement

Vibrating switches

SITRANS LVL200

Selection and Ordering data	Article No.
SITRANS LVL200, Standard	7ML5746-
Compact vibrating level switch for material detection in liquid and slurry applications such as overflow, high, low, and demand applications, as well as pump protection. For use in SIL-2 and hazardous applications.	
Flange 4" 150 lb LT, ASME B16.5/316L	D 3 5
Flange 4" 300 lb RF, ASME B16.5/316L	D 3 6
Flange 4" 300 lb RF, ASME B16.5/Alloy C22 (2.4602)	D 3 7
Flange 4" 300 lb RF, ASME B16.5/ECTFE ⁴⁾	D 3 8
Flange 4" 300 lb RJF, ASME B16.5/316L	D 4 0
Flange 4" 300 lb LG, ASME B16.5/316L	D 4 1
Flange 4" 300 lb LT, ASME B16.5/316L	D 4 2
Flange 4" 600 lb RF, ASME B16.5/316L	D 4 3
Flange 4" 600 lb RJF, ASME B16.5/316L	D 4 4
Flange 6" 150 lb RF, ASME B16.5/316L	D 4 5
Flange 6" 150 lb RF, ASME B16.5/Alloy C22 (2.4602)	D 4 6
Flange 6" 150 lb RF, ASME B16.5/ECTFE ⁴⁾	D 4 7
Flange 6" 150 lb RF, ASME B16.5/PFA ⁴⁾	D 4 8
Flange 6" 150 lb RJF, ASME B16.5/316L	D 5 0
Flange 6" 300 lb RF, ASME B16.5/316L	D 5 1
Flange 8" 150 lb RF, ASME B16.5/316L	D 5 2
Flange 8" 150 lb RF, ASME B16.5/ECTFE ⁴⁾	D 5 3
Flange 1" BS.10 Table E/316L	D 5 4
Flange 1" BS.10 Table E/PFA ⁴⁾	D 5 5
Flange 1½" BS.10 Table E/316L	D 5 6
Flange 3½" BS.10 Table E/316L	D 5 7
Flange 4" BS.10 Table E/ECTFE ⁴⁾	D 5 8
Flange DN 40 10K, JIS/316L	D 6 0
Flange DN 50 10K, JIS/316L	D 6 1
Flange DN 80 10K, JIS/316L	D 6 2
Flange DN 100 10K, JIS/316L	D 6 3
Thread R1 PN 64, EN 10226-1/316L	D 6 5
Flange 2" 900 lb RF, ASME B16.5/316L	D 7 0
Adapter/Process temperature	
Without adapter/-50 ... +150 °C (-58 ... +302 °F)	1
With adapter/-50 ... +200 °C (-58 ... +392 °F) ¹³⁾	2
With adapter/-50 ... +250 °C (-58 ... +482 °F)	3
With gas-tight leadthrough/-50 ... +150 °C (-58 ... +302 °F)	4
With gas-tight leadthrough/-50 ... +250 °C (-58 ... +482 °F)	5
Housing/Cable entry	
Aluminum IP66/IP67/M20 x 1.5	A
Aluminum IP66/IP67/½" NPT	B
316L stainless steel (electropolished) IP66/IP67/M20 x 1.5	C
316L stainless steel (electropolished) IP66/IP67/½" NPT	D
Plastic single chamber IP66/IP67/M20 x 1.5	E
Plastic single chamber IP66/IP67/½" NPT	F
Stainless steel chamber (precision casting) IP66/ IP67/M20 x 1.5	G
Stainless steel chamber (precision casting) IP66/ IP67/½" NPT	H
Aluminum IP66/IP67/M20 x 1.5 Special HARTING plug (bent) according to Tier One (ZB7555) ¹¹⁾	V

Selection and Ordering data	Order code
Further designs	
Please add "-Z" to Article No. and specify Order code(s).	
Switching status indication with colors red-green ¹²⁾	A21
Cleaning including Certificate (oil, grease, and silicone free)	W01
Identification label (measurement loop) stainless steel: max. 40 characters, add in plain text. To add more than one line, use a coma "," for line break.	Y17
Identification Label (measurement loop) foil: max. 40 characters add in plain text. To add more than one line, use a coma "," for line break.	Y18
NACE0175 to 3.1 Material Certificate for material (EN10204 NACE MR 0175) ⁸⁾ Note: not available with Process Connection and Rigid extension coatings PFA, ECTFE, and Enamel. NACE not available with Hygienic process connections.	D07
Material Inspection certificate 3.1 of EN 10204 ⁸⁾	C05
2.2-Factory certificate for material (EN 10204) ⁸⁾	C15
Functional Safety (SIL 2). Device suitable for use in accordance with IEC 61508 and IEC 61511 ⁸⁾	C20
Dye penetration test, results confirmed via a 3.1 certificate/instrument (EN10204) ⁸⁾	C13
X-ray test + 3.1 certificate/instrument ⁸⁾	C14
Positive material identification test + 3.1 certificate/instrument ⁸⁾	C16
Roughness test + 3.1 certificate/instrument ⁸⁾	C18
3.1-Inspection Certificate for instrument with test data (EN 10204)	C25
Quality and test plan	C26
Pressure test + 3.1 certificate/instrument ⁸⁾	C31
Helium leak test + 3.1 certificate/instrument ⁸⁾	C32
Ferrite measuring accuracy to DIN32514-1 + 3.1 certificate/instrument ⁸⁾	C60
Pressure test according to Norsok + 3.1 certificate/instrument ⁸⁾	C61
Operating Instructions	
All literature is available to download for free, in a range of languages, at http://www.siemens.com/processinstrumentation/documentation	
Spare Parts and Accessories	
Electronics module SITRANS LVL200 Relay	7ML1830-1NC
Electronics module SITRANS LVL200 Contactless	7ML1930-6AA
NAMUR spare electronics module	A5E35817107
SITRANS SCSC single channel signal conditioner and remote test	7ML5760
SITRANS TCSC two channel signal conditioner and remote test	7ML5761
LVL200 Threaded Welded Socket	
• G ³ / ₄ " A/316L with FKM Seal	7ML1930-1EE
• G1" A/316L with FKM Seal	7ML1930-1EF
• M27 x 1.5/316L with FKM Seal	7ML1930-1EG
• G ³ / ₄ " A/316L with EPDM Seal	7ML1930-1EH
• G1" A/316L with EPDM Seal	7ML1930-1EJ
• M27 x 1.5/316L with EPDM Seal	7ML1930-1EK

- 4) Not available with Adapter/Process Temperature options 2, 3, and 5.
- 5) Not available with Adapter/Process Temperature options 2, 4, and 5.
- 6) Available only with Electronics options 4 and 6.
- 7) Not available with ECTFE coated probe options.
- 8) Listed Certificates are not available with all configurations please contact factory for more information.
- 9) Not available with Housing/Protection/Cable Option V.
- 10) Not available with PFA and ECTFE coating options.
- 11) Available only with Approval option A.
- 12) Available only with Relay Electronic options and Non-hazardous Approval options.
- 13) Available only with Enamelled Process connection options.
- 14) Available only with Electronic options 4, 5, and 6.
- 15) Available only with Aluminum Housing/Protection/Cable options.
- 16) Not available with Stainless Steel (electropolished) Housing/Protection/Cable options and certain glands.
- 17) Not available with Plastic and Stainless Steel (electropolished) Housing/Protection/Cable options and certain glands.
- 18) Not available with Housing/Protection/Cable options D, and V.
- 19) Not available with Plastic Housing/Protection/Cable options and certain glands.
- 20) Not available with Housing/Protection/Cable options A, E, G, and V.
- 21) Available only with Housing/Protection/Cable options B, D, F, and H.
- 22) Not available with Housing/Protection/Cable options C and V.
- 23) Available only with Housing/Protection/Cable options A, B, and H.
- 24) Not available with Approval options C, E, G, H, L, N, V, and W.
- 25) Not available with Approval options C, E, G, H, N, V, and W.

- 1) Available only with Adapter/Process temperature options 1, 3, 4, and 5.
- 2) Available only with Housing/Protection/Cable option B.
- 3) Available only with Adapter/Process Temperature options 1, 2, and 4.

Level Measurement

Point level measurement

Vibrating switches

SITRANS LVL200

Selection and Ordering data

Article No.

SITRANS LVL200, Rigid extension

➔ 7ML5747-

Compact vibrating level switch for material detection in liquid applications such as overflow, high, low, and demand applications, as well as pump protection. For use in SIL-2 and hazardous applications.

➔ Click on the Article No. for the online configuration in the PIA Life Cycle Portal.

Electronics

Contactless electronic switch 20 ... 250 V AC/DC¹⁾⁹⁾¹⁴⁾

1

Double relay (DPDT) 20 ... 72 V DC/20 ... 250 V AC¹⁴⁾

2

NAMUR signal⁹⁾

4

Transistor (NPN/PNP) 10 ... 55 V DC¹⁾¹⁵⁾

5

Two-wire (8/16 mA) 12 ... 36 V DC

6

Approvals

Without approvals

Overfill protection (WHG)⁹⁾

ATEX II 1G, 1/2G, 2G Ex ia IIC T6 + WHG⁶⁾⁹⁾

ATEX II 1/2G, 2G Ex d IIC T6 + WHG⁵⁾⁷⁾¹⁶⁾

ATEX II 1G, 1/2G, 2G Ex ia IIC T6 + shipping approvals⁶⁾¹⁷⁾

ATEX II 1/2G, 2G Ex d IIC T6 + shipping approvals⁵⁾⁷⁾¹⁶⁾

ATEX II 1G, 1/2G, 2G Ex ia IIC T6 + ATEX II 1/2D IP6X T⁶⁾⁸⁾¹⁸⁾

IECEX Ex ia IIC T6⁶⁾¹⁹⁾

Shipping approvals¹⁷⁾

ATEX II 3G Ex nA II T5 ... T1 X¹⁸⁾

FM (IS) Class I, II, III, Div. 1, Groups A, B, C, D, E, F, G⁶⁾²⁰⁾

FM (XP) Class I, Div. 1, Groups A, B, C, D; (DIP) Class II, III, Div. 1, Groups E, F, G²⁾⁵⁾

FM (NI) Class I, Div. 2, Groups A, B, C, D²⁾¹⁾

IECEX d IIC T6 ... T2 Ga/Gb⁵⁾⁷⁾¹⁶⁾

CSA(XP) Class I,II,III Div. 1, Groups A, B, C, D, E, F, G²⁾⁵⁾⁷⁾

CSA(NI)Class I,II,III, Div. 2, Groups A, B, C, D, E, F, G²⁾²⁾

BR-Ex d IIC T6 ... T2⁵⁾¹⁸⁾

CSA (IS) Class I, II, III Div. 1, Groups A, B, C, D, E, F, G⁶⁾⁹⁾

ATEX II 1G, 1/2G, 2G Ex ia IIC T6⁶⁾

ATEX II 1G, 1/2G, 2G Ex ia IIC T6⁶⁾

ATEX II 1G, 1/2G, 2G Ex ia IIC T6⁶⁾

ATEX II 1G, 1/2G, 2G Ex ia IIC T6⁶⁾

ATEX II 1G, 1/2G, 2G Ex ia IIC T6⁶⁾

ATEX II 1G, 1/2G, 2G Ex ia IIC T6⁶⁾

ATEX II 1G, 1/2G, 2G Ex ia IIC T6⁶⁾

ATEX II 1G, 1/2G, 2G Ex ia IIC T6⁶⁾

ATEX II 1G, 1/2G, 2G Ex ia IIC T6⁶⁾

ATEX II 1G, 1/2G, 2G Ex ia IIC T6⁶⁾

ATEX II 1G, 1/2G, 2G Ex ia IIC T6⁶⁾

ATEX II 1G, 1/2G, 2G Ex ia IIC T6⁶⁾

ATEX II 1G, 1/2G, 2G Ex ia IIC T6⁶⁾

ATEX II 1G, 1/2G, 2G Ex ia IIC T6⁶⁾

ATEX II 1G, 1/2G, 2G Ex ia IIC T6⁶⁾

ATEX II 1G, 1/2G, 2G Ex ia IIC T6⁶⁾

ATEX II 1G, 1/2G, 2G Ex ia IIC T6⁶⁾

ATEX II 1G, 1/2G, 2G Ex ia IIC T6⁶⁾

ATEX II 1G, 1/2G, 2G Ex ia IIC T6⁶⁾

ATEX II 1G, 1/2G, 2G Ex ia IIC T6⁶⁾

ATEX II 1G, 1/2G, 2G Ex ia IIC T6⁶⁾

ATEX II 1G, 1/2G, 2G Ex ia IIC T6⁶⁾

ATEX II 1G, 1/2G, 2G Ex ia IIC T6⁶⁾

ATEX II 1G, 1/2G, 2G Ex ia IIC T6⁶⁾

ATEX II 1G, 1/2G, 2G Ex ia IIC T6⁶⁾

ATEX II 1G, 1/2G, 2G Ex ia IIC T6⁶⁾

ATEX II 1G, 1/2G, 2G Ex ia IIC T6⁶⁾

ATEX II 1G, 1/2G, 2G Ex ia IIC T6⁶⁾

ATEX II 1G, 1/2G, 2G Ex ia IIC T6⁶⁾

ATEX II 1G, 1/2G, 2G Ex ia IIC T6⁶⁾

ATEX II 1G, 1/2G, 2G Ex ia IIC T6⁶⁾

Selection and Ordering data

Article No.

SITRANS LVL200, Rigid extension

7ML5747-

Compact vibrating level switch for material detection in liquid applications such as overflow, high, low, and demand applications, as well as pump protection. For use in SIL-2 and hazardous applications.

Thread G1½" A, PN 64/316L

A 2 1

Thread G1½" A, PN 64/316L Ra <0.8 µm

A 2 2

Thread G1½" A, PN 64/Alloy C22 (2.4602)

A 2 3

Thread 1" NPT, PN 64/Alloy C22 (2.4602)

A 2 4

Thread 1½" NPT, PN 64/316L

A 2 5

Thread 1½" NPT, PN 64/316L Ra < 0.8 µm

A 2 6

Thread 1½" NPT, PN 64/Alloy C22 (2.4602)

A 2 7

Thread G2" A, PN 64/316L

A 2 8

Thread M27 x 1.5 PN 64/316L

A 3 0

Cyl. socket/316Ti/1.4581 ECTFE coated ZB2984⁴⁾

A 3 1

Conus DN 25 PN 40/316L Ra < 0.3 µm

A 3 2

Conus DN 25 PN 40/316L Ra < 0.8 µm

A 3 3

Conus DN 25 PN 40/ECTFE (ZB3033)⁴⁾

A 3 4

Conus M52 PN 40/316L

A 3 5

Conus M52 PN 40/316L Ra < 0.3 µm

A 3 6

Conus M52 PN 40/316L Ra < 0.8 µm

A 3 7

Tri-Clamp 1" PN 16/316L Ra < 0.3 µm

A 3 8

Tri-Clamp 1" PN 16/Alloy C22 (2.4602)

A 4 0

Tri-Clamp 1" PN 16/316L Ra < 0.8 µm

A 4 1

Tri-Clamp 1½" PN 16/316L Ra < 0.3 µm

A 4 2

Tri-Clamp 1½" PN 16/Alloy C22 (2.4602)

A 4 3

Tri-Clamp 1½" PN 16/316L Ra < 0.8 µm

A 4 4

Tri-Clamp 2" PN 16/316L Ra < 0.3 µm

A 4 5

Tri-Clamp 2" PN 16/Alloy C22 (2.4602)

A 4 6

Tri-Clamp 2" PN 16/316L Ra < 0.8 µm

A 4 7

Tri-Clamp 2½" PN 10/316L Ra < 0.3 µm

A 4 8

Tri-Clamp 2½" PN 10/316L Ra < 0.8 µm

A 5 0

Tri-Clamp 3" PN 10/316L Ra < 0.3 µm

A 5 1

Tri-Clamp 3" PN 10/316L Ra < 0.8 µm

A 5 2

Bolting DN 32 PN 40 DIN11851/316L Ra < 0.3 µm

A 5 3

Bolting DN 32 PN 40 DIN11851/316L Ra < 0.8 µm

A 5 4

Bolting DN 25 PN 40 DIN11851/316L Ra < 0.3 µm

A 5 5

Bolting DN 25 PN 40 DIN11851/316L Ra < 0.8 µm

A 5 6

Bolting DN 40 PN 40 DIN11851/316L Ra < 0.3 µm

A 5 7

Bolting DN 40 PN 40 DIN11851/316L Ra < 0.8 µm

A 5 8

Bolting DN 40 PN 40 DIN11864-1 A/316L

A 6 0

Ra < 0.8 µm ZB3052

Bolting DN 50 PN 25 DIN11851/316L Ra < 0.3 µm

A 6 1

Bolting DN 50 PN 25 DIN11851/316L Ra < 0.8 µm

A 6 2

Bolting DN 50 PN 25 DIN11864-1 A/316L

A 6 3

Ra < 0.8 µm ZB3052

Hygienic w.compr.nut F40 PN 25/316L

A 6 4

Hygienic w.compr.nut F40 PN 25/316L Ra < 0.3 µm

A 6 5

Hygienic w.compr.nut F40 PN 25/316L Ra < 0.8 µm

A 6 6

Varivent N50-40/316L Ra < 0.3 µm

A 6 7

Varivent N50-40/316L Ra < 0.8 µm

A 6 8

Varivent N125/100/316L Ra < 0.8 µm

A 7 0

DRD flange PN 40/316L ZB3007

A 7 1

SMS DN 38/316L Ra < 0.8 µm⁴⁾

A 7 2

SMS DN 51 PN 6/316L Ra < 0.8 µm⁴⁾

A 7 3

Swagelok VCR screwing ZG2579 PN 64/316L

A 7 4

Neumo biocontrol size 25 PN 16/316L Ra < 0.8 µm

A 7 5

Neumo biocontrol size 50 PN 16/316L Ra < 0.8 µm

A 7 6

SÜDMO DN 50 PN 10/316L Ra < 0.8 µm

A 8 0

Small flange DN 25 PN 1.5 DIN 28403/316L pol.

A 8 1

Ra < 0.8 µm

Small flange DN 40 PN 1.5 DIN 28403/316L pol.

A 8 2

Ra < 0.8 µm

Ingold connection PN 16/316L Ra < 0.8 µm

A 8 3

4

Selection and Ordering data	Article No.	Selection and Ordering data	Article No.
SITRANS LVL200, Rigid extension Compact vibrating level switch for material detection in liquid applications such as overflow, high, low, and demand applications, as well as pump protection. For use in SIL-2 and hazardous applications.	7ML5747-	SITRANS LVL200, Rigid extension Compact vibrating level switch for material detection in liquid applications such as overflow, high, low, and demand applications, as well as pump protection. For use in SIL-2 and hazardous applications.	7ML5747-
Collar clamp connection DN33,7 PN40 Form A, DIN11864-3/1.4435 (BN2, Ra < 0.8 µm)	A 84	Flange DN 65 PN 40 Form C, DIN 2501/ECTFE ⁴⁾	B 47
Collar flange DN50 PN16 Form A, DIN11864-2/316L (Ra < 0.8 µm)	A 85	Flange DN 65 PN 40 Form C, DIN 2501/PFA ⁴⁾	B 48
Flange DN 25 PN 6 Form C, DIN 2501/316L	A 86	Flange DN 65 PN 40 Form F, DIN 2501/316L	B 50
Flange DN 25 PN 6 Form C, DIN 2501/PFA ⁴⁾	A 87	Flange DN 65 PN 64 Form E, DIN 2501/316L	B 51
Flange DN 25 PN 40 Form C, DIN 2501/316L	A 88	Flange DN 80 PN 40 Form C, DIN 2501/316L	B 52
Flange DN 25 PN 40 Form C, DIN 2501/Alloy C22 (2.4602) plated	B 00	Flange DN 80 PN 40 Form C, DIN 2501/Alloy C22 (2.4602) plated	B 53
Flange DN 25 PN 40 Form C, DIN 2501/ECTFE ⁴⁾	B 01	Flange DN 80 PN 40 Form C, DIN 2501/ECTFE ⁴⁾	B 54
Flange DN 25 PN 40 Form C, DIN 2501/PFA ⁴⁾	B 02	Flange DN 80 PN 40 Form C, DIN 2501/PFA ⁴⁾	B 55
Flange DN 25 PN 40 Form D, DIN 2501/316L	B 03	Flange DN 80 PN 40 Form F, DIN 2501/316L	B 56
Flange DN 25 PN 40 Form F, DIN 2501/316L	B 04	Flange DN 80 PN 40 Form N, DIN 2501/316L	B 57
Flange DN 25 PN 40 Form N, DIN 2501/316L	B 05	Flange DN 80 PN 40 Form N, DIN 2501/Alloy C22 (2.4602) plated	B 58
Flange DN 25 PN 40 Form N, DIN 2501/Alloy C22 (2.4602) plated	B 06	Flange DN 100 PN 16 Form C, DIN 2501/316L	B 60
Flange DN 25 PN 40 Form N, DIN 2501/Alloy 400 (2.4360) solid	B 07	Flange DN 100 PN 16 Form C, DIN 2501/Alloy C22 (2.4602) plated	B 61
Flange DN 25 PN 40 V13, DIN 2501/316L	B 08	Flange DN 100 PN 16 Form C, DIN 2501/ECTFE ⁴⁾	B 62
Flange DN 32 PN 40 Form C, DIN 2501/316L	B 10	Flange DN 100 PN 16 Form C, DIN 2501/PFA ⁴⁾	B 63
Flange DN 32 PN 40 Form C, DIN 2501/ECTFE ⁴⁾	B 11	Flange DN 100 PN 16 Form D, DIN 2501/316L	B 64
Flange DN 40 PN 6 Form C, DIN 2501/316L	B 12	Flange DN 100 PN 16 Form F, DIN 2501/316L	B 65
Flange DN 40 PN 6 Form C, DIN 2501/ECTFE ⁴⁾	B 13	Flange DN 100 PN 16 Form N, DIN 2501/316L	B 66
Flange DN 40 PN 40 Form C, DIN 2501/316L	B 14	Flange DN 100 PN 40 Form C, DIN 2501/316L	B 67
Flange DN 40 PN 40 Form C, DIN 2501/Alloy C22 (2.4602) plated	B 15	Flange DN 100 PN 40 Form C, DIN 2501/ECTFE ⁴⁾	B 68
Flange DN 40 PN 40 Form C, DIN 2501/ECTFE ⁴⁾	B 16	Flange DN 100 PN 40 Form C, DIN 2501/PFA ⁴⁾	B 70
Flange DN 40 PN 40 Form C, DIN 2501/PFA ⁴⁾	B 17	Flange DN 100 PN 40 Form C, DIN 2501/Enamelled ³⁾	B 71
Flange DN 40 PN 40 Form C, DIN 2501/Enamelled ³⁾	B 18	Flange DN 100 PN 40 Form F, DIN 2501/316L	B 72
Flange DN 40 PN 40 Form F, DIN 2501/316L	B 20	Flange DN 100 PN 40 Form N, DIN 2501/316L	B 73
Flange DN 40 PN 40 Form N, DIN 2501/316L	B 21	Flange DN 100 PN 40 V13, DIN 2501/316L	B 74
Flange DN 40 PN 40 Form E, DIN 2501/316L	B 22	Flange DN 100 PN 64 Form E, DIN 2501/316L	B 75
Flange DN 40 PN 40 V13, DIN 2501/316L	B 23	Flange DN 100 PN 100 Form E, DIN 2501/316L	B 76
Flange DN 50 PN 40 Form C, DIN 2501/316L	B 24	Flange DN 100 PN 100 Form L, DIN 2501/316L	B 77
Flange DN 50 PN 40 Form C, DIN 2501/Alloy C22 (2.4602) plated	B 25	Flange DN 125 PN 16 Form F, DIN 2501/316L	B 78
Flange DN 50 PN 40 Form C, DIN 2501/ECTFE ⁴⁾	B 26	Flange DN 125 PN 40 Form C, DIN 2501/316L	B 80
Flange DN 50 PN 40 Form C, DIN 2501/ECTFE (ZB3108) ⁴⁾	B 27	Flange DN 125 PN 40 Form N, DIN 2512/316L	B 81
Flange DN 50 PN 40 Form C, DIN 2501/PFA ⁴⁾	B 28	Flange DN 150 PN 16 Form C, DIN 2501/316L	B 82
Flange DN 50 PN 40 Form D, DIN 2501/316L	B 30	Flange DN 150 PN 16 Form C, DIN 2501/Alloy C22 (2.4602) plated	B 83
Flange DN 50 PN 40 Form D, DIN 2501/Alloy C22 (2.4602)	B 31	Flange DN 150 PN 16 Form C, DIN 2501/ECTFE ⁴⁾	B 84
Flange DN 50 PN 40 Form F, DIN 2501/316L	B 32	Flange DN 150 PN 16 Form C, DIN 2501/PFA ⁴⁾	B 85
Flange DN 50 PN 40 Form N, DIN 2501/316L	B 33	Flange DN 150 PN 16 Form D, DIN 2501/316L	B 86
Flange DN 50 PN 40 Form N, DIN 2501/Alloy C22 (2.4602) solid	B 34	Flange DN 150 PN 40 Form C, DIN 2501/316L	B 87
Flange DN 50 PN 40 Form E, DIN 2501/316L	B 35	Flange DN 150 PN 40 Form C, DIN 2501/Alloy C22 (2.4602) plated	B 88
Flange DN 50 PN 40 V13, DIN 2501/316L	B 36	Flange DN 150 PN 40 Form F, DIN 2501/316L	C 00
Flange DN 50 PN 40 R13, DIN 2501/316L	B 37	Flange DN 150 PN 40 Form N, DIN 2512/316L	C 01
Flange DN 50 PN 64 Form F, DIN 2501/316L	B 38	Flange DN 200 PN 10 Form C, DIN 2501/ECTFE ⁴⁾	C 02
Flange DN 50 PN 64 Form N, DIN 2501/Alloy C22 (2.4602) plated	B 40	Flange DN 200 PN 16 Form C, DIN 2501/316L	C 03
Flange DN 50 PN 64 Form C, DIN 2501/316L	B 41	Flange DN 25 PN 40 Form B1, EN 1092-1/316L	C 04
Flange DN 50 PN 64 Form L, DIN 2501/316L	B 42	Flange DN 25 PN 40 Form B1, EN 1092-1/Alloy C22 (2.4602) plated	C 05
Flange DN 50 PN 100 Form E, DIN 2501/316L	B 43	Flange DN 25 PN 40 Form B1, EN/316L/PFA ⁴⁾	C 06
Flange DN 50 PN 100 Form L, DIN 2501/316L	B 44	Flange DN 25 PN 40 Form B1, EN 1092-1/Enamelled ³⁾	C 07
Flange DN 65 PN 40 Form C, DIN 2501/316L	B 45	Flange DN 25 PN 40 Form B2, EN 1092-1/316L	C 08
Flange DN 65 PN 40 Form C, DIN 2501/Alloy C22 (2.4602) plated	B 46	Flange DN 25 PN 40 Form F, EN 1092-1/316L	C 10
		Flange DN 25 PN 63 Form B1, EN 1092-1/316L	C 11
		Flange DN 25 PN 100 Form B2, EN 1092-1/316L	C 12
		Flange DN 40 PN 40 Form B1, EN/316L	C 13
		Flange DN 40 PN 40 Form B1, EN 1092-1/PFA ⁴⁾	C 14
		Flange DN 40 PN 40 Form B2, EN/316L	C 15

Level Measurement

Point level measurement

Vibrating switches

SITRANS LVL200

Selection and Ordering data

Article No.

SITRANS LVL200, Rigid extension

Compact vibrating level switch for material detection in liquid applications such as overflow, high, low, and demand applications, as well as pump protection. For use in SIL-2 and hazardous applications.

	7ML5747-
Flange DN 50 PN 40 Form B1, EN/316L	C 16
Flange DN 50 PN 40 Form B1, EN 1092-1/ Alloy C22 (2.4602) plated	C 17
Flange DN 50 PN 40 Form B1, EN 1092-1/ Alloy 400 (2.4360) ZB2977	C 18
Flange DN 50 PN 40 Form B1, EN 1092-1/ECTFE ⁴⁾	C 20
Flange DN 50 PN 40 Form B1, EN/316L/PFA ⁴⁾	C 21
Flange DN 50 PN 40 Form B1, EN 1092-1/ Enamelled ³⁾	C 22
Flange DN 50 PN 40 Form C, EN 1092-1/316L	C 23
Flange DN 50 PN 40 Form D, EN/316L	C 24
Flange DN 50 PN 40 Form D, EN 1092-1/ Alloy C22 (2.4602) plated	C 25
Flange DN 50 PN 40 Form B2, EN 1092-1/316L	C 26
Flange DN 50 PN 40 Form E, EN 1092-1/316L	C 27
Flange DN 80 PN 40 Form B1, EN 1092-1/316L	C 28
Flange DN 80 PN 40 Form B1, EN 1092-1/ Alloy C22 (2.4602) plated	C 30
Flange DN 80 PN 40 Form B1, EN 1092-1/ECTFE ⁴⁾	C 31
Flange DN 80 PN 40 Form B1, EN 1092-1/ Enamelled ³⁾	C 32
Flange DN 80 PN 40 Form B2, EN 1092-1/316L	C 33
Flange DN 100 PN 16 Form B1, EN 1092-1/316L	C 34
Flange DN 100 PN 16 Form B1, EN 1092-1/ Alloy C22 (2.4602) plated	C 35
Flange DN 100 PN 16 Form B1, EN 1092-1/ Enamelled ³⁾	C 36
Flange DN 100 PN 40 Form B1, EN 1092-1/316L	C 37
Flange DN 100 PN 40 Form B1, EN 1092-1/ Enamelled ³⁾	C 38
Flange DN 100 PN 40 Form C, EN 1092-1/316L	C 40
Flange DN 100 PN 63 Form B2, EN 1092-1/316L	C 41
Flange DN 150 PN 16 Form B1, EN 1092-1/316L	C 42
Flange DN 150 PN 16 Form B1, EN 1092-1/PFA ⁴⁾	C 43
Flange DN 150 PN 40 Form B1, EN 1092-1/316L	C 44
Flange DN 150 PN 40 Form B1, EN 1092-1/ECT- FE ⁴⁾	C 45
Flange DN 150 PN 40 Form B2, EN 1092-1/316L	C 46
Flange 1" 150 lb ASME B16.5/316L	C 47
Flange 1" 150 lb RF, ASME B16.5/ Alloy C22 (2.4602) plated	C 48
Flange 1" 150 lb RF, ASME B16.5// Alloy 400 (2.4360) ZB2977	C 50
Flange 1" 150 lb RF, ASME B16.5/ECTFE ⁴⁾	C 51
Flange 1" 150 lb RF, ASME B16.5/PFA ⁴⁾	C 52
Flange 1" 150 lb RF, ASME B16.5/Enamelled ³⁾	C 53
Flange 1" 300 lb RF, ASME B16.5/316L	C 54
Flange 1" 300 lb RF, ASME B16.5/ECTFE ⁴⁾	C 55
Flange 1" 600 lb RF, ASME B16.5/316L	C 56
Flange 1½" 150 lb RF, ASME B16.5/316L	C 57
Flange 1½" 150 lb RF, ASME B16.5/ Alloy C22 (2.4602) plated	C 58
Flange 1½" 150 lb RF, ASME B16.5/ECTFE ⁴⁾	C 60
Flange 1½" 150 lb RF, ASME B16.5/PFA ⁴⁾	C 61
Flange 1½" 150 lb RF, ASME B16.5 Enamelled ³⁾	C 62
Flange 1½" 150 lb FF, ASME B16.5/ECTFE ⁴⁾	C 63
Flange 1½" 300 lb RF, ASME B16.5/316L	C 64
Flange 1½" 300 lb RF, ASME B16.5/ Alloy 400 (2.4360) ZB2977	C 65
Flange 1½" 300 lb RF, ASME B16.5/ECTFE ⁴⁾	C 66

Selection and Ordering data

Article No.

SITRANS LVL200, Rigid extension

Compact vibrating level switch for material detection in liquid applications such as overflow, high, low, and demand applications, as well as pump protection. For use in SIL-2 and hazardous applications.

	7ML5747-
Flange 1½" 600 lb RF, ASME B16.5/316L	C 67
Flange 2" 150 lb RF, ASME B16.5/316L	C 68
Flange 2" 150 lb RF, ASME B16.5/Alloy C22 (2.4602) plated	C 70
Flange 2" 150 lb RF, ASME B16.5/ Alloy 400 (2.4360) ZB2977	C 71
Flange 2" 150 lb RF, ASME B16.5/ECTFE ⁴⁾	C 72
Flange 2" 150 lb RF, ASME B16.5/PFA ⁴⁾	C 73
Flange 2" 150 lb RF, ASME B16.5/Enamelled ³⁾	C 74
Flange 2" 150 lb FF, ASME B16.5/316L	C 75
Flange 2" 150 lb FF, ASME B16.5/ECTFE ⁴⁾	C 76
Flange 2" 150 lb SG (small groove), ASME B16.5/316L	C 77
Flange 2" 300 lb RF, ASME B16.5/316L	C 78
Flange 2" 300 lb RF, ASME B16.5/Alloy C22 (2.4602) plated	C 80
Flange 2" 300 lb RF, ASME B16.5/ECTFE ⁴⁾	C 82
Flange 2" 300 lb RF, ASME B16.5/PFA ⁴⁾	C 83
Flange 2" 300 lb RJF, ASME B16.5/316L	C 85
Flange 2" 300 lb ST, ASME B16.5/316L	C 86
Flange 2" 300 lb LG (large groove), ASME B16.5/316L	C 87
Flange 2" 300 lb LT, ASME B16.5/316L	C 88
Flange 2" 600 lb RF, ASME B16.5/316L	D 00
Flange 2" 600 lb RF, ASME B16.5/Alloy 400 (2.4360) ZB2977	D 01
Flange 2" 600 lb RF, ASME B16.5/ECTFE ⁴⁾	D 02
Flange 2" 600 lb RJF, ASME B16.5/316L	D 03
Flange 2" 600 lb LG, ASME B16.5/316L	D 04
Flange 2" 900 lb RJF, ASME B16.5/316L	D 05
Flange 2½" 150 lb RF, ASME B16.5/316L	D 06
Flange 2½" 300 lb RF, ASME B16.5/316L	D 07
Flange 3" 150 lb RF, ASME B16.5/316L	D 08
Flange 3" 150 lb RF, ASME B16.5/Alloy C22 (2.4602) plated	D 10
Flange 3" 150 lb RF, ASME B16.5/Alloy 400 (2.4360) ZB2977	D 11
Flange 3" 150 lb RF, ASME B16.5/ECTFE ⁴⁾	D 12
Flange 3" 150 lb RF, ASME B16.5/PFA ⁴⁾	D 13
Flange 3" 150 lb RF, ASME B16.5/Enamelled ³⁾	D 14
Flange 3" 150 lb FF, ASME B16.5/316L	D 15
Flange 3" 150 lb FF, ASME B16.5/ECTFE ⁴⁾	D 16
Flange 3" 150 lb FF, ASME B16.5/PFA ⁴⁾	D 17
Flange 3" 300 lb RF, ASME B16.5/316L	D 18
Flange 3" 300 lb RF, ASME B16.5/Alloy C22 (2.4602) plated	D 20
Flange 3" 300 lb RF, ASME B16.5/ECTFE ⁴⁾	D 21
Flange 3" 300 lb RF, ASME B16.5/PFA ⁴⁾	D 22
Flange 3" 300 lb RF, ASME B16.5/Enamelled ³⁾	D 23
Flange 3" 600 lb RF, ASME B16.5/316L	D 24
Flange 3½" 150 lb RF, ASME B16.5/316L	D 25
Flange 3½" 150 lb RF, ASME B16.5/ECTFE ⁴⁾	D 26
Flange 4" 150 lb RF, ASME B16.5/316L	D 27
Flange 4" 150 lb RF, ASME B16.5/Alloy C22 (2.4602) plated	D 28
Flange 4" 150 lb RF, ASME B16.5/ECTFE ⁴⁾	D 30
Flange 4" 150 lb RF, ASME B16.5/PFA ⁴⁾	D 31
Flange 4" 150 lb RF, ASME B16.5/Enamelled ³⁾	D 32
Flange 4" 150 lb LT, ASME B16.5/316L	D 33

Selection and Ordering data	Article No.	Selection and Ordering data	Article No.
SITRANS LVL200, Rigid extension Compact vibrating level switch for material detection in liquid applications such as overflow, high, low, and demand applications, as well as pump protection. For use in SIL-2 and hazardous applications.	7ML5747-	SITRANS LVL200, Rigid extension Compact vibrating level switch for material detection in liquid applications such as overflow, high, low, and demand applications, as well as pump protection. For use in SIL-2 and hazardous applications.	7ML5747-
Flange 4" 300 lb RF, ASME B16.5/316L	D 3 4	1 501 ... 2 000 mm	A 3
Flange 4" 300 lb RF, ASME B16.5/Alloy C22 (2.4602) plated	D 3 5	2 001 ... 2 500 mm	A 4
Flange 4" 300 lb RF, ASME B16.5/ECTFE ⁴⁾	D 3 6	2 501 ... 3 000 mm	A 5
Flange 4" 300 lb RJF, ASME B16.5/316L	D 3 7	3 001 ... 3 500 mm	A 6
Flange 4" 300 lb LG, ASME B16.5/316L	D 3 8	3 501 ... 4 000 mm	A 7
Flange 4" 300 lb LT, ASME B16.5/316L	D 4 0		
Flange 4" 600 lb RF, ASME B16.5/316L	D 4 1	Rigid Extension ECTFE coated	
Flange 4" 600 lb RJF, ASME B16.5/316L	D 4 2	80 ... 500 mm	B 0
Flange 5" 150 lb RF, ASME B16.5/316L	D 4 3	501 ... 1 000 mm	B 1
Flange 6" 150 lb RF, ASME B16.5/316L	D 4 4	1 001 ... 1 500 mm	B 2
Flange 6" 150 lb RF, ASME B16.5/Alloy C22 (2.4602) plated	D 4 5	1 501 ... 2 000 mm	B 3
Flange 6" 150 lb RF, ASME B16.5/ECTFE ⁴⁾	D 4 6	2 001 ... 2 500 mm	B 4
Flange 6" 150 lb RF, ASME B16.5/PFA ⁴⁾	D 4 7	2 501 ... 3 000 mm	B 5
Flange 6" 150 lb RJF, ASME B16.5/316L	D 4 8		
Flange 6" 300 lb RF, ASME B16.5/316L	D 5 0	Rigid Extension PFA coated	
Flange 8" 150 lb RF, ASME B16.5/316L	D 5 1	80 ... 500 mm	C 0
Flange 8" 150 lb RF, ASME B16.5/ECTFE ⁴⁾	D 5 2	501 ... 1 000 mm	C 1
Flange 1" BS.10 Table E/316L	D 5 3	1 001 ... 1 500 mm	C 2
Flange 1" BS.10 Table E/PFA ⁴⁾	D 5 4	1 501 ... 2 000 mm	C 3
Flange 1½" BS.10 Table E/316L	D 5 5	2 001 ... 2 500 mm	C 4
Flange 3½" BS.10 Table E/316L	D 5 6	2 501 ... 3 000 mm	C 5
Flange 4" BS.10 Table E/ECTFE ⁴⁾	D 5 7	3 001 ... 3 500 mm	C 6
Flange DN 40 10K, JIS/316L	D 5 8	3 501 ... 4 000 mm	C 7
Flange DN 50 10K, JIS/316L	D 6 0		
Flange DN 80 10K, JIS/316L	D 6 1	Rigid Extension 316L Ra ≤ 0.8 µm	
Flange DN 100 10K, JIS/316L	D 6 2	80 ... 500 mm	D 0
Thread R1 PN64, EN10226-1/316L ¹¹⁾	D 6 5	501 ... 1 000 mm	D 1
Flange 2" 900 lb RF, ASME B16.5/316L	D 7 0	1 001 ... 1 500 mm	D 2
Flange 4" 150 lb RF, ASME B16.5/Alloy C22 (2.4602) solid	D 7 1	1 501 ... 2 000 mm	D 3
		2 001 ... 2 500 mm	D 4
		2 501 ... 3 000 mm	D 5
		3 001 ... 3 500 mm	D 6
		3 501 ... 4 000 mm	D 7
Adapter/Process temperature			
Without adapter/-50 ... +150 °C	1	Rigid Extension 316L Ra ≤ 0.3 µm	
With adapter/-50 ... +200 °C ¹³⁾	2	80 ... 500 mm	E 0
With adapter/-50 ... +250 °C ¹⁰⁾	3	501 ... 1 000 mm	E 1
		1 001 ... 1 500 mm	E 2
With gas-tight leadthrough/-50 ... +150 °C	4	1 501 ... 2 000 mm	E 3
With gas-tight leadthrough/-50 ... +250 °C ¹⁰⁾	5	2 001 ... 2 500 mm	E 4
		2 501 ... 3 000 mm	E 5
		3 001 ... 3 500 mm	E 6
		3 501 ... 4 000 mm	E 7
Housing/Cable entry			
Aluminum IP66/IP67/M20 x 1.5	A	Rigid Extension Enamelled version	
Aluminum IP66/IP67/½" NPT	B	80 ... 250 mm	F 0
316L stainless steel (electropolished) IP66/IP67/M20 x 1.5	C	251 ... 500 mm	F 1
316L stainless steel (electropolished) IP66/IP67/½" NPT	D	501 ... 750 mm	F 2
Plastic single chamber IP66/IP67/M20 x 1.5	E	751 ... 1 000 mm	F 3
Plastic single chamber IP66/IP67/½" NPT	F	1 001 ... 1 250 mm	F 4
Stainless steel chamber (precision casting) IP66/IP67/M20 x 1.5	G	1 251 ... 1 500 mm	F 5
Stainless steel chamber (precision casting) IP66/IP67/½" NPT	H		
Aluminum IP66/IP67/M20 x 1.5 Special HARTING plug (bent) according to Tier One (ZB7555)	V	Rigid Extension Alloy C22 (2.4602)	
		80 ... 500 mm	G 0
		501 ... 1 000 mm	G 1
		1 001 ... 1 500 mm	G 2
		1 501 ... 2 000 mm	G 3
		2 001 ... 2 500 mm	G 4
		2 501 ... 3 000 mm	G 5
		3 001 ... 3 500 mm	G 6
		3 501 ... 4 000 mm	G 7
NOTE:			
When selecting a Rigid Extension option, extension coating must match the process connection coating and the material and surface roughness type.			
Rigid Extension 316L			
80 ... 500 mm	A 0		
501 ... 1 000 mm	A 1		
1 001 ... 1 500 mm	A 2		

Level Measurement

Point level measurement

Vibrating switches

SITRANS LVL200

Selection and Ordering data

Article No.

SITRANS LVL200, Rigid extension

Compact vibrating level switch for material detection in liquid applications such as overflow, high, low, and demand applications, as well as pump protection. For use in SIL-2 and hazardous applications.

7ML5747-



Rigid Extension Alloy 400 (2.4360)

80 ... 500 mm
501 ... 1 000 mm
1 001 ... 1 500 mm
1 501 ... 2 000 mm
2 001 ... 2 500 mm
2 501 ... 3 000 mm

H 0
H 1
H 2
H 3
H 4
H 5

Selection and Ordering data

Order code

Further designs

Please add **"-Z"** to Article No. and specify Order code(s).

Switching status indication with colors red-green¹²⁾

A21

Cleaning including Certificate (oil, grease, and silicone free)

W01

Enter the total insertion length in plain text description, max. 4 000 mm (157.48 inch)

Y01

Identification label (measurement loop) stainless steel: max. 40 characters, add in plain text. To add more than one line, use a comma "," for line break.

Y17

Identification Label (measurement loop) foil: max. 40 characters add in plain text. To add more than one line, use a comma "," for line break.

Y18

NACE0175 to 3.1 Material Certificate for material (EN10204 NACE MR 0175)⁸⁾
Note: not available with Process connection and Rigid extension coatings PFA, ECTFE, and Enamel. NACE not available with Hygienic process connections.

D07

Material Inspection certificate 3.1 of EN 10204⁸⁾

C05

2.2-Factory certificate for material (EN 10204)⁸⁾

C15

Functional Safety (SIL 2). Device suitable for use in accordance with IEC 61508 and IEC 61511⁹⁾

C20

Dye penetration test, results confirmed via a 3.1 certificate/instrument⁸⁾

C13

X-ray test + 3.1 certificate/instrument⁸⁾

C14

Positive material identification test + 3.1 certificate/instrument⁸⁾

C16

Roughness test + 3.1 certificate/instrument⁸⁾

C18

3.1-Inspection Certificate for instrument with test data (EN 10204)

C25

Quality and test plan

C26

Pressure test + 3.1 certificate/instrument⁸⁾

C31

Helium leak test + 3.1 certificate/instrument⁸⁾

C32

Ferrite measuring accuracy to DIN 32514-1 + 3.1 certificate/instrument⁸⁾

C60

Pressure test according to Norsok + 3.1 certificate/instrument⁸⁾

C61

Operating Instructions

All literature is available to download for free, in a range of languages, at <http://www.siemens.com/processinstrumentation/documentation>

Selection and Ordering data

Article No.

Spare Parts and Accessories

Electronics module SITRANS LVL200 Relay

7ML1830-1NC

Electronics module SITRANS LVL200 Contactless

7ML1930-6AA

NAMUR spare electronics module

A5E35817107

SITRANS SCSC single channel signal conditioner and remote test

7ML5760

SITRANS TCSC two channel signal conditioner and remote test

7ML5761

Lock fitting, unpressurized, G1" A/316L

7ML1930-1DQ

Lock fitting, unpressurized, 1" NPT/316L

7ML1930-1DR

Lock fitting, unpressurized, G1 ... 1/2" A/316L

7ML1930-1DS

Lock fitting, unpressurized, 1 ... 1/2" NPT/316L

7ML1930-1DT

Lock fitting, -1 ... 16 bar, G1" A/316L

7ML1930-1DU

Lock fitting, -1 ... 16 bar, 1" NPT/316L

7ML1930-1DV

Lock fitting, -1 ... 16 bar, G1 ... 1/2" A/316L

7ML1930-1DW

Lock fitting, -1 ... 16 bar, 1 ... 1/2" NPT/316L

7ML1930-1DX

Lock fitting, -1 ... 64 bar, G1" A/316L

7ML1930-1EA

Lock fitting, -1 ... 64 bar, 1" NPT/316L

7ML1930-1EB

Lock fitting, -1 ... 64 bar, G1 ... 1/2" A/316L

7ML1930-1EC

Lock fitting, -1 ... 64 bar, 1 ... 1/2" NPT/316L

7ML1930-1ED

1) Available only with Adapter/Process temperature options 1, 3, 4, and 5.

2) Available only with Housing/Cable entry option B.

3) Available only with Adapter/Process temperature options 1, 2, and 4.

4) Not available with Adapter/Process temperature options 2, 3, and 5.

5) Not available with Adapter/Process temperature options 2, 4, and 5.

6) Available only with Electronics options 4 and 6.

7) Available only with rigid extension options less than 3 001 mm.

8) Listed Certificates are not available with all configurations please contact factory for more information.

9) Not available with Housing/Protection/Cable option V.

10) Not available with PFA, ECTFE, and enamelled coating options.

11) Available only with some 316L extensions.

12) Available only with relay electronic options and non-hazardous Approval options.

13) Available only with Enamelled Process connection/Material options.

14) Not available with Approval options C, E, G, H, L, N, V, and W.

15) Not available with Approval options C, E, G, H, N, and V.

16) Only available with Aluminum Housing/Protection/Cable options and certain glands.

17) Not available with Stainless Steel Electropolish Housing/Protection/Cable options and certain glands.

18) Not available with Plastic or Stainless Steel Electropolish Housing/Protection/Cable options and certain glands.

19) Not available with Housing/Protection/Cable options D and V.

20) Not available with Housing/Protection/Cable options A, E, G, and V.

21) Not available with some Housing/Protection/Cable gland options.

22) Not available with Housing/Protection/Cable options A, C, and V.

Selection and Ordering data	Article No.	Selection and Ordering data	Article No.
SITRANS LVL200, High temperature Rigid extended vibrating level switch for use in aggressive liquids and hazardous applications such as overflow, high, and low demand applications, as well as pump protection. For use in SIL-2 applications. ↗ Click on the Article No. for the online configuration in the PIA Life Cycle Portal.	7ML5748- 	SITRANS LVL200, High temperature Rigid extended vibrating level switch for use in aggressive liquids and hazardous applications such as overflow, high, and low demand applications, as well as pump protection. For use in SIL-2 applications.	7ML5748-
Version/Material Compact version/Inconel 718 (2.4668) ¹⁾²⁾ With tube extension/316L and Inconel 718 (2.4668) ¹⁾³⁾ With tube extension/Alloy C22 (2.4602) and Inconel 718 (2.4668) ⁴⁾	1 2 3	Flange DN 250 PN 16 Form C, DIN 2501/316/316L Flange DN 250 PN 64 Form C, DIN 2501/316/316L Flange DN 50 PN 40 Form B1, EN 1092-1/1.4435 Flange DN 50 PN 40 Form B1, EN 1092-1/316/316L Flange DN 50 PN 40 Form B1, EN 1092-1/316/316L, with Alloy C22 (2.4602) coating Flange DN 50 PN 40 Form B2, EN 1092-1/316/316L Flange DN 50 PN 40 Form C, EN 1092-1/316/316L Flange DN 50 PN 40 Form D, EN 1092-1/316/316L Flange DN 50 PN 40 Form E, EN 1092-1/316/316L Flange DN 50 PN 63 Form B2, EN 1092-1/316/316L Flange DN 50 PN 63 Form B2, EN 1092-1/316/316L, with Alloy C22 (2.4602) coating Flange DN 50 PN 63 Form C, EN 1092-1/316/316L Flange DN 50 PN 63 Form D, EN 1092-1/316/316L Flange DN 50 PN 100 Form B1, EN 1092-01/316/316L Flange DN 50 PN 100 Form C, EN 1092-1/316/316L Flange DN 50 PN 160 Form B1, EN 1092-1/316/316L Flange DN 50 PN 160 Form B2, EN 1092-1/316/316L Flange DN 50 PN 250 Form B1, EN 1092-1/316/316L Flange DN 50 PN 250 Form B2, EN 1092-1/316/316L Flange DN 65 PN 40 Form B1, EN 1092-1/316/316L Flange DN 65 PN 63 Form C, EN 1092-1/316/316L Flange DN 80 PN 40 Form B1, EN 1092-1/316/316L Flange DN 80 PN 40 Form B2, EN 1092-1/316/316L Flange DN 80 PN 40 Form C, EN 1092-1/316/316L Flange DN 80 PN 40 Form D, EN 1092-1/316/316L Flange DN 80 PN 63 Form B2, EN 1092-1/316/316L Flange DN 80 PN 160 Form B2, EN 1092-1/316/316L Flange DN 80 PN 250 Form B1, EN 1092-1/316/316L Flange DN 100 PN 16 Form D, EN 1092-1/316/316L Flange DN 100 PN 40 Form B1, EN 1092-1/316/316L Flange DN 100 PN 40 Form B2, EN 1092-1/316/316L Flange DN 100 PN 40 Form C, EN 1092-1/316/316L Flange DN 100 PN 40 Form D, EN 1092-1/316/316L Flange DN 100 PN 160 Form B2, EN 1092-1/316/316L Flange DN 125 PN 63 Form C, EN 1092-1/316/316L Flange DN 125 PN 160 Form B2, EN 1092-1/316/316L Flange DN 150 PN 16 Form C, DIN 2501/316/316L Flange DN 150 PN 16 Form C, DIN 2501/316/316L, with Alloy C22 (2.4602) coating Flange DN 150 PN 40 Form C, DIN 2501/316/316L Flange DN 150 PN 160 Form L, DIN 2501/316/316L Flange DN 200 PN 16 Form C, DIN 2501/316/316L Flange DN 200 PN 64 Form C, DIN 2501/316/316L	E 1 E 2 E 3 E 4 E 5 E 6 E 7 E 8 F 0 F 1 F 2 F 3 F 4 F 5 F 6 F 7 F 8 G 0 G 1 G 2 G 3 G 4 G 5 G 6 G 7 G 8 H 0 H 1 H 2 H 3 H 4 H 5 H 6 H 7 H 8 K 0 K 1 K 2 K 3 K 4 K 5 K 6 K 7 K 8
Approvals Without approvals	A		
Process connection Thread G1 PN 100, DIN 3852-A/316L Thread G1 PN 160, DIN 3852-A/ Inconel 718 (2.4668) Thread 1" NPT PN 100, ASME B1.20.1/316L Thread 1" NPT PN 160, ASME B1.20.1/ Inconel 718 (2.4668) Flange DN 50 PN 40 Form C, DIN 2501/316/316 Flange DN 50 PN 40 Form C, DIN 2501/316/316L, with Alloy C22 (2.4602) coating Flange DN 50 PN 40 Form N, DIN 2501/316/316L Flange DN 50 PN 40 Form V13, DIN 2501/316/316L Flange DN 50 PN 40 Form V13, DIN 2501/Alloy C22 (2.4602) solid Flange DN 50 PN 40 Form V13, DIN 2501/316/ 316L, with Alloy C22 (2.4602) coating Flange DN 50 PN 64 Form E, DIN 2501/316/316L Flange DN 50 PN 100 Form C, DIN 2501/316/316L Flange DN 50 PN 100 Form F, DIN 2501/316/316L Flange DN 50 PN 100 Form V13, DIN 2501/316/316L Flange DN 50 PN 160 Form C, DIN 2501/316/316L Flange DN 50 PN 160 Form F, DIN 2501/316/316L Flange DN 65 PN 16 Form C, DIN 2501/316/316L Flange DN 65 PN 40 Form C, DIN 2501/316/316L Flange DN 65 PN 100 Form C, DIN 2501/316/316L Flange DN 80 PN 40 Form C, DIN 2501/316/316L Flange DN 80 PN 100 Form C, DIN 2501/316/316L Flange DN 80 PN 160 Form F, DIN 2501/316/316L Flange DN 80 PN 160 Form L, DIN 2501/316/316L Flange DN 80 PN 250 Form L, DIN 2501/316/316L Flange DN 80 PN 250 Form L, DIN 2501/ Alloy C22 (2.4602) solid Flange DN 100 PN 16 Form C, DIN 2501/316/316L Flange DN 100 PN 40 Form C, DIN 2501/316/316L Flange DN 100 PN 100 Form E, DIN 2501/316/316L Flange DN 100 PN 160 Form L, DIN 2501/316/316L Flange DN 125 PN 16 Form C, DIN 2501/316/316L Flange DN 125 PN 40 Form C, DIN 2501/316/316L Flange DN 150 PN 16 Form C, DIN 2501/316/316L Flange DN 150 PN 16 Form C, DIN 2501/316/316L, with Alloy C22 (2.4602) coating Flange DN 150 PN 40 Form C, DIN 2501/316/316L Flange DN 150 PN 160 Form L, DIN 2501/316/316L Flange DN 200 PN 16 Form C, DIN 2501/316/316L Flange DN 200 PN 64 Form C, DIN 2501/316/316L	A 0 A 1 A 2 A 3 A 4 A 5 A 6 A 7 A 8 B 0 B 1 B 2 B 3 B 4 B 5 B 6 B 7 B 8 C 0 C 1 C 2 C 3 C 4 C 5 C 6 C 7 C 8 D 0 D 1 D 2 D 3 D 4 D 5 D 6 D 7 D 8 E 0		

Level Measurement

Point level measurement

Vibrating switches

SITRANS LVL200

Selection and Ordering data

Article No.

SITRANS LVL200, High temperature

7ML5748-

Rigid extended vibrating level switch for use in aggressive liquids and hazardous applications such as overflow, high, and low demand applications, as well as pump protection. For use in SIL-2 applications.

Flange 1½" 300 lb RJF, ASME B16.5/316/316L	L 1
Flange 1½" 1 500 lb RJF, ASME B16.5/316/316L	L 2
Flange 2" 150 lb RF, ASME B16.5/316/316L	L 3
Flange 2" 150 lb RF, ASME B16.5/Alloy C22 (2.4602) solid	L 4
Flange 2" 300 lb RF, ASME B16.5/316/316L	L 5
Flange 2" 300 lb RF, ASME B16.5/Alloy C22 (2.4602) solid	L 6
Flange 2" 300 lb RF, ASME B16.5/316/316L, with Alloy C22 (2.4602) coating	L 7
Flange 2" 300 lb ST (small tongue), ASME B16.5/316/316L	L 8
Flange 2" 300 lb RJF, ASME B16.5/316/316L	M 1
Flange 2" 300 lb LM (large male), ASME B16.5/316/316L	M 2
Flange 2" 300 lb SG, ASME B16.5/316/316L	M 3
Flange 2" 300 lb LG, ASME B16.5/316/316L	M 4
Flange 2" 600 lb RF, ASME B16.5/316/316L	M 5
Flange 2" 600 lb RF, ASME B16.5/316/316L, with Alloy C22 (2.4602) coating	M 6
Flange 2" 600 lb RJF, ASME B16.5/316/316L	M 7
Flange 2" 900 lb RF, ASME B16.5/316/316L	M 8
Flange 2" 900 lb RJF, ASME B16.5/316/316L	N 1
Flange 2" 1 500 lb RF, ASME B16.5/316/16L	N 2
Flange 2" 1 500 lb RJF, ASME B16.5/316/316L	N 3
Flange 2" 1 500 lb LT, ASME B16.5/Alloy C22 (2.4602) solid	N 4
Flange 2" 1 500 lb LM, ASME B16.5/316/316L	N 5
Flange 2" 2 500 lb RJF, ASME B16.5/316/316L	N 6
Flange 2½" 150 lb RF, ASME B16.5/316/316L	N 7
Flange 2½" 300 lb RF, ASME B16.5/316/316L	N 8
Flange 2½" 600 lb RF, ASME B16.5/316/316L	P 1
Flange 2½" 900 lb RF, ASME B16.5/316/316L	P 2
Flange 2½" 2 500 lb RJF, ASME B16.5/316/316L	P 3
Flange 3" 150 lb RF, ASME B16.5/316/316L	P 4
Flange 3" 150 lb RF, ASME B16.5/Alloy C22 (2.4602) solid	P 5
Flange 3" 300 lb RF, ASME B16.5/316/316L	P 6
Flange 3" 300 lb RJF, ASME B16.5/316/316L	P 7
Flange 3" 300 lb LT, ASME B16.5/316/316L	P 8
Flange 3" 600 lb RF, ASME B16.5/316/316L	R 1
Flange 3" 600 lb RF, ASME B16.5/Alloy C22 (2.4602) solid	R 2
Flange 3" 600 lb RF, ASME B16.5/316/316L, with Alloy C22 (2.4602) coating	R 3
Flange 3" 600 lb RJF, ASME B16.5/316/316L	R 4
Flange 3" 900 lb RF, ASME B16.5/316/316L	R 5
Flange 3" 900 lb RJF, ASME B16.5/316/316L	R 6
Flange 3" 1 500 lb RF, ASME B16.5/316/316L	R 7
Flange 3" 1500lb RJF, ASME B16.5 / 316/316L	R 8
Flange 3" 2 500 lb RF, ASME B16.5/316/316L	S 1
Flange 3" 2 500 lb RJF, ASME B16.5/316/316L	S 2
Flange 4" 150 lb RF, ASME B16.5/316/316L	S 3
Flange 4" 150 lb RF, ASME B16.5/Alloy C22 (2.4602) solid	S 4
Flange 4" 150 lb RJF, ASME B16.5/316/316L	S 5
Flange 4" 300 lb RF, ASME B16.5/316/316L	S 6
Flange 4" 300 lb RF, ASME B16.5/Alloy C22 (2.4602) solid	S 7
Flange 4" 300 lb LT, ASME B16.5/316/316L	S 8
Flange 4" 600 lb RF, ASME B16.5/316/316L	T 1

Selection and Ordering data

Article No.

SITRANS LVL200, High temperature

7ML5748-

Rigid extended vibrating level switch for use in aggressive liquids and hazardous applications such as overflow, high, and low demand applications, as well as pump protection. For use in SIL-2 applications.

Flange 4" 600 lb RF, ASME B16.5/Alloy C22 (2.4602) solid	T 2
Flange 4" 600 lb RJF, ASME B16.5/316/316L	T 3
Flange 4" 900 lb RF, ASME B16.5/316/316L	T 4
Flange 4" 900 lb RJF, ASME B16.5/316/316L	T 5
Flange 4" 900 lb LT, ASME B16.5/316/316L	T 6
Flange 4" 1 500 lb RF, ASME B16.5/316/316L	T 7
Flange 4" 1 500 lb RJF, ASME B16.5/316/316L	T 8
Flange 4" 1 500 lb LT, ASME B16.5/316/316L	U 1
Flange 5" 150 lb RF, ASME B16.5/316/316L	U 2
Flange 5" 300 lb RF, ASME B16.5/316/316L	U 3
Flange 5" 600 lb RJF, ASME B16.5/316/316L	U 4
Flange 6" 150 lb RF, ASME B16.5/316/316L	U 5
Flange 6" 300 lb RF, ASME B16.5/316/316L	U 6
Flange 6" 300 lb LT, ASME B16.5/316/316L	U 7
Flange DN 50 30K RF, JIS/316/316L	U 8
Flange DN 50 40K RF, JIS/316/316L	V 1
Flange DN 65 40 K RF, JIS/316/316L	V 2
Mobrey flange PN 16 Form A/316/316L	V 3
Mobrey flange PN 16 Form E/316/316L	V 4

Adapter/Process temperature

With adapter/-196 ... +450 °C (-321 ... +842 °F)	1
Without/-196 ... +450 °C (-321 ... +842 °F)	2

Electronics

Relay (2 x SPDT) 20 ... 72 V DC/20 ... 253 V AC (5A)	1
Transistor (NPN/PNP) 9.6 ... 55 V DC	2
Two-wire (8/16 mA) 9.6 ... 35 V DC	3

Housing/Cable entry

Plastic single chamber/IP66/IP67/M20 x 1.5	A
Plastic single chamber/IP66/IP67/½" NPT	B
Aluminum IP66/IP67/M20 x 1.5	C
Aluminum IP66/IP67/½" NPT	D
Stainless steel single chamber (precision casting)/IP66/IP67/M20 x 1.5	E
Stainless steel single chamber (precision casting)/IP66/IP67/½" NPT	F
Stainless steel single chamber (electropolished)/IP66/IP67/M20 x 1.5	G
Stainless steel single chamber (electropolished)/IP66/IP67/½" NPT	H

Rigid Extension 316L

200 ... 500 mm	A 0
501 ... 1 000 mm	A 1
1 001 ... 1 500 mm	A 2
1 501 ... 2 000 mm	A 3
2 001 ... 2 500 mm	A 4
2 501 ... 3 000 mm	A 5

Rigid Extension Alloy C22

200 ... 500 mm	B 0
501 ... 1 000 mm	B 1
1 001 ... 1 500 mm	B 2
1 501 ... 2 000 mm	B 3
2 001 ... 2 500 mm	B 4
2 501 ... 3 000 mm	B 5
75 mm compact version	C 1

Selection and Ordering data	Order code
Further designs	
Please add "-Z" to Article No. and specify Order code(s).	
Enter the total insertion length in plain text description.	Y01
Cleaning including Certificate (oil, grease, and silicone free).	W01
Identification label (measurement loop) stainless steel.	Y17
Identification Label (measurement loop) foil.	Y18
Spare Parts and Accessories	
SITRANS SCSC single channel signal conditioner and remote test	7ML5760
SITRANS TCSC two channel signal conditioner and remote test	7ML5761
Operating Instructions	
All literature is available to download for free, in a range of languages, at http://www.siemens.com/processinstrumentation/documentation	

- 1) Not available with Process Connection options A0 and A2.
 2) Available only with Rigid extension option C1.
 3) Available only with 316L Process Connection and Rigid extension options.
 4) Available only with Alloy C22 Rigid extension options.

Selection and Ordering data	Article No.
SITRANS SCSC, single channel, signal conditioner for SITRANS LVL200	7ML5760-
Single channel signal conditioning instrument for level detection with relay output for one LVL vibrating switch with electronics version two-wire 8/16 mA. Provides remote test of LVL200.	A 1 -
Click on the Article No. for the online configuration in the PIA Life Cycle Portal.	
Approvals	
For Ex-free area	1 A
ATEX II (1) G/D [Ex ia Ga/Da] IIC/IIIC, I (M1) [Ex ia Ma] I	1 D
ATEX II (1) G/D (Ex ia Ga/Da) IIC/IIIC, I (M1) (Ex ia Ma) I + WHG	1 E
IEC [Ex ia Ga] IIC, [Ex ia Da] IIIC, [Ex ia Ma] I	1 H
IEC (Ex ia Ga) IIC, (Ex ia Da) IIIC, (Ex ia Ma) I + WHG	1 J
SIL qualification	
Without	1
With	2
Version	
Single-channel (8/16 mA) for level detection	1
Single channel (8/16 mA), level detection with fail safe relay	2
Housing/cable entry	
Plastic/IP20	A
Terminal block connection	
Detachable 2.5 mm ² / Ex sensor: 2 x blue; output and operating voltage: 2 x black	A
Detachable 2.5 mm ² / sensor: 2 x black; output and operating voltage: 2 x black	B
Language	
English	0
German	1

Selection and Ordering data	Order code
Operating Instructions	
All literature is available to download for free, in a range of languages, at http://www.siemens.com/processinstrumentation/documentation	

Selection and Ordering data	Article No.
SITRANS TCSC, two channel, signal conditioner for SITRANS LVL200	7ML5761-
Two channel signal conditioning instrument for level detection with relay output for two LVL vibrating switches with electronics version two-wire 8/16 mA. Provides remote test of LVL200.	A 1 -
Click on the Article No. for the online configuration in the PIA Life Cycle Portal.	
Approvals	
For Ex-free area ¹⁾	1 A
ATEX II (1) G/D [Ex ia Ga/Da] IIC/IIIC, I (M1) [Ex ia Ma] I ²⁾	1 D
ATEX II (1) G/D (Ex ia Ga/Da) IIC/IIIC, I (M1) (Ex ia Ma) I + WHG	1 E
IEC [Ex ia Ga] IIC, [Ex ia Da] IIIC, [Ex ia Ma] I ²⁾	1 H
IEC (Ex ia Ga) IIC, (Ex ia Da) IIIC, (Ex ia Ma) I + WHG	1 J
SIL qualification	
Without	1
With	2
Version	
Double-channel (8/16 mA) for level detection	1
Housing/cable entry	
Plastic/IP20	A
Terminal block connection	
Detachable 2.5 mm ² / Ex sensor: 2 x blue; output and operating voltage: 2 x black	A
Detachable 2.5 mm ² / sensor: 2 x black; output and operating voltage: 2 x black	B
Language	
English	0
German	1

Selection and Ordering data	Order code
Operating Instructions	
All literature is available to download for free, in a range of languages, at http://www.siemens.com/processinstrumentation/documentation	
1) Available only with terminal block connection option B	
2) Available only with terminal block connection option A	

Level Measurement

Point level measurement

Vibrating switches

SITRANS LVL200

Options

LVL200 threaded welded socket

G $\frac{3}{4}$ " A/316L

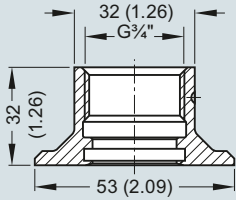

G1" A/316L

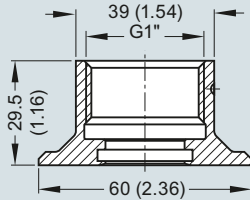

Lock fitting

LVL200 extended
64 bar

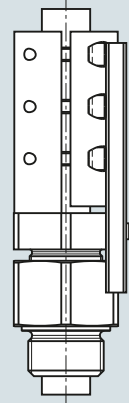

LVL200 extended
16 bar

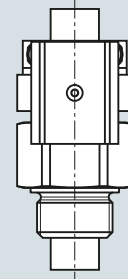

LVL200 extended
unpressurized

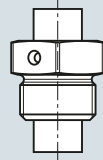

SITRANS LVL200 welded socket and lock fitting, dimensions in mm (inch)

SITRANS SCSC and TCSC LVL test conditioner

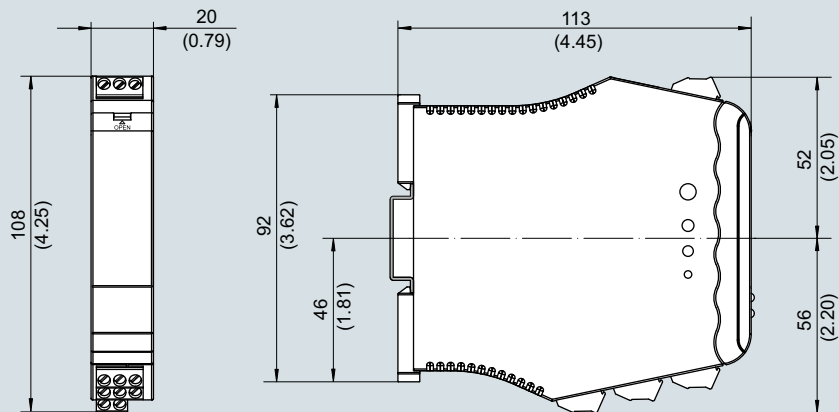

SITRANS SCSC and SITRANS TCSC LVL Test Conditioners, dimensions in mm (inch)

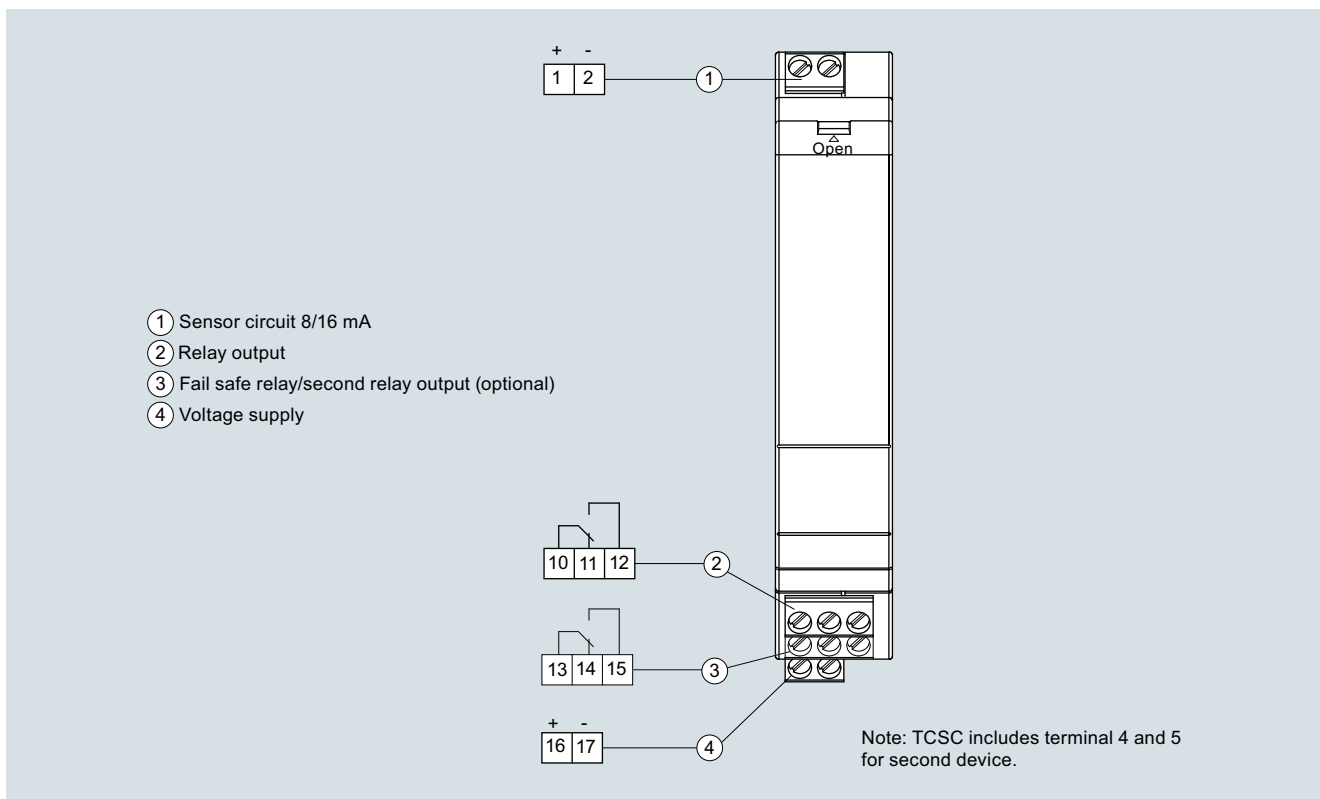

SITRANS SCSC and SITRANS TCSC LVL Test Conditioner connections

Level Measurement

Point level measurement

Vibrating switches

SITRANS LVL200

Characteristic curves

Ambient/Process temperature

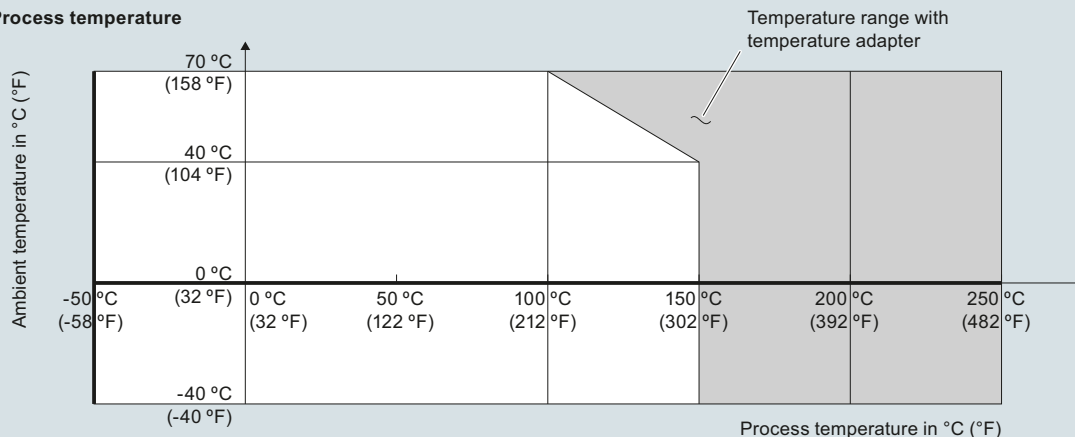

Process pressure with switch position 0.7 g/cm³ (mode switch)

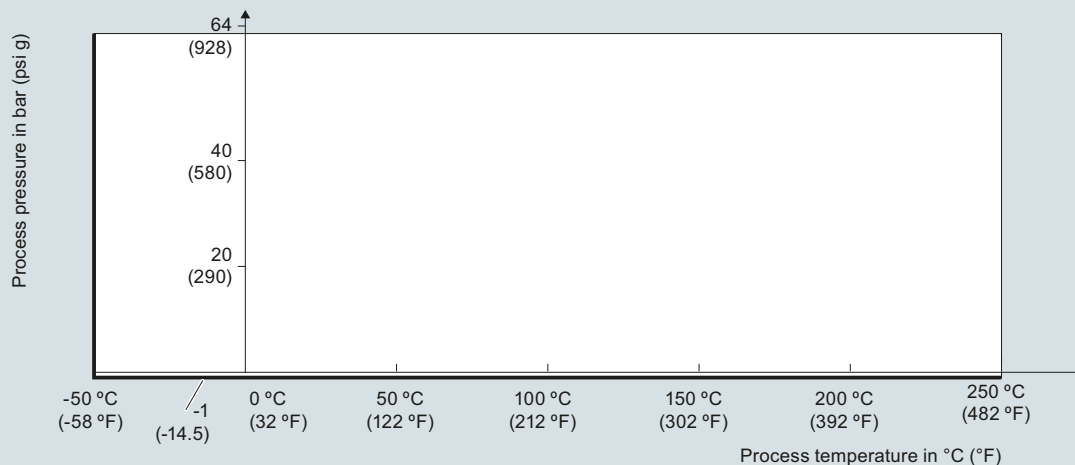

Process pressure with switch position 0.5 g/cm³ (mode switch)

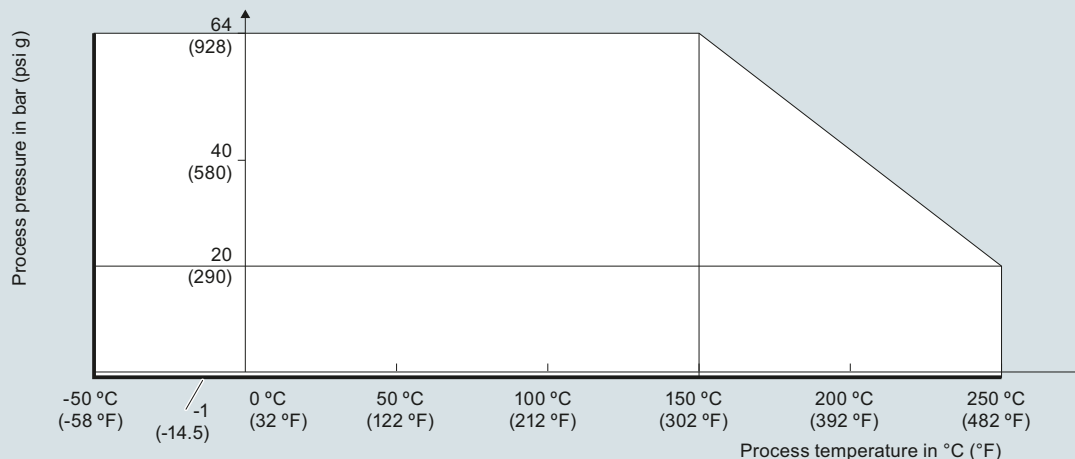

SITRANS LVL200 process pressure/process temperature/ambient temperature derating curves

SITRANS LVL high temperature process temperature/process pressure, version up to 100 bar (1 450 psig)

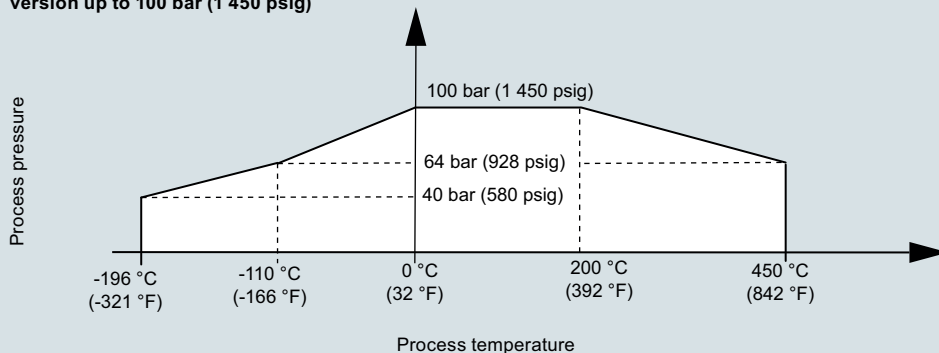

SITRANS LVL200 high temperature, process temperature/process pressure version up to 100 bar (1 450 psig)

SITRANS LVL200 high temperature pressure/temperature curve, version up to 160 bar (2 321 psig)

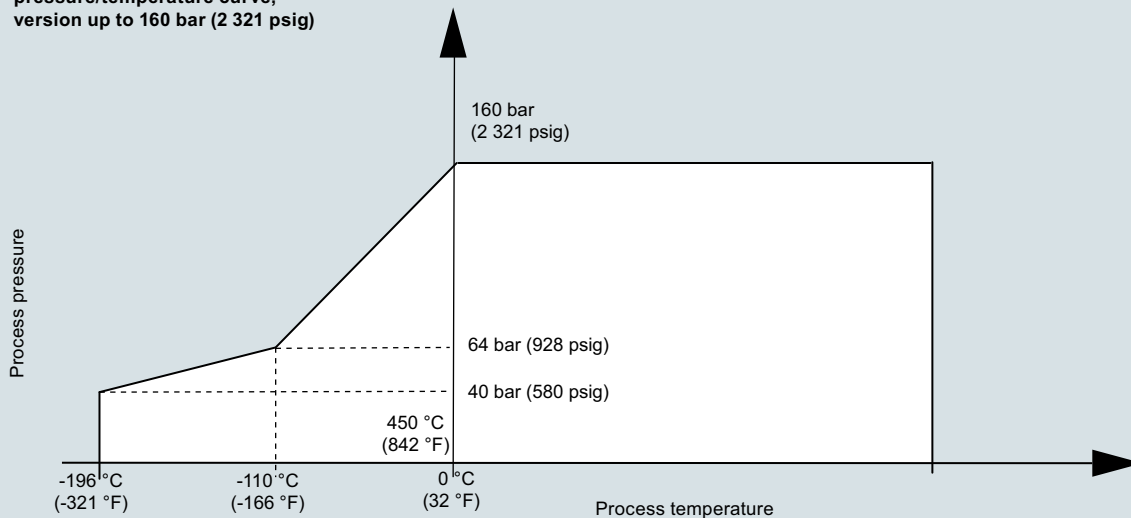

SITRANS LVL200 high temperature, pressure/temperature, version up to 160 bar (2 321 psig)

SITRANS LVL100 high temperature ambient temperature/process temperature

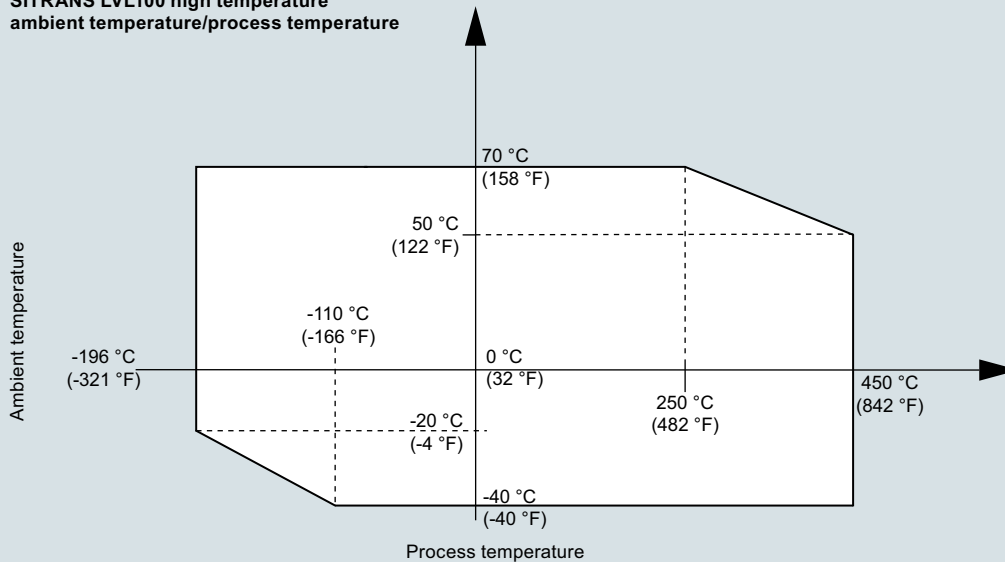

SITRANS LVL200 high temperature ambient temperature/process temperature, version up to 100 bar (1 450 psig)

4

Level Measurement

Point level measurement

Vibrating switches

SITRANS LVL200

Dimensional drawings

SITRANS LVL200, housing

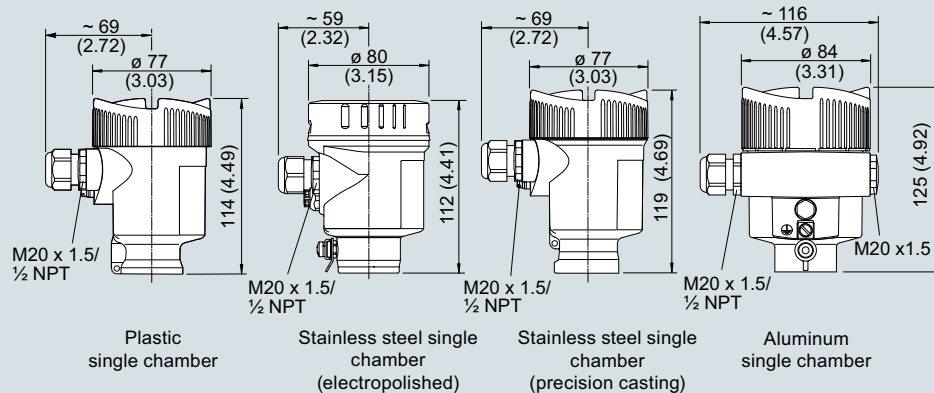

SITRANS LVL200 housing, dimensions in mm (inch)

SITRANS LVL200 standard

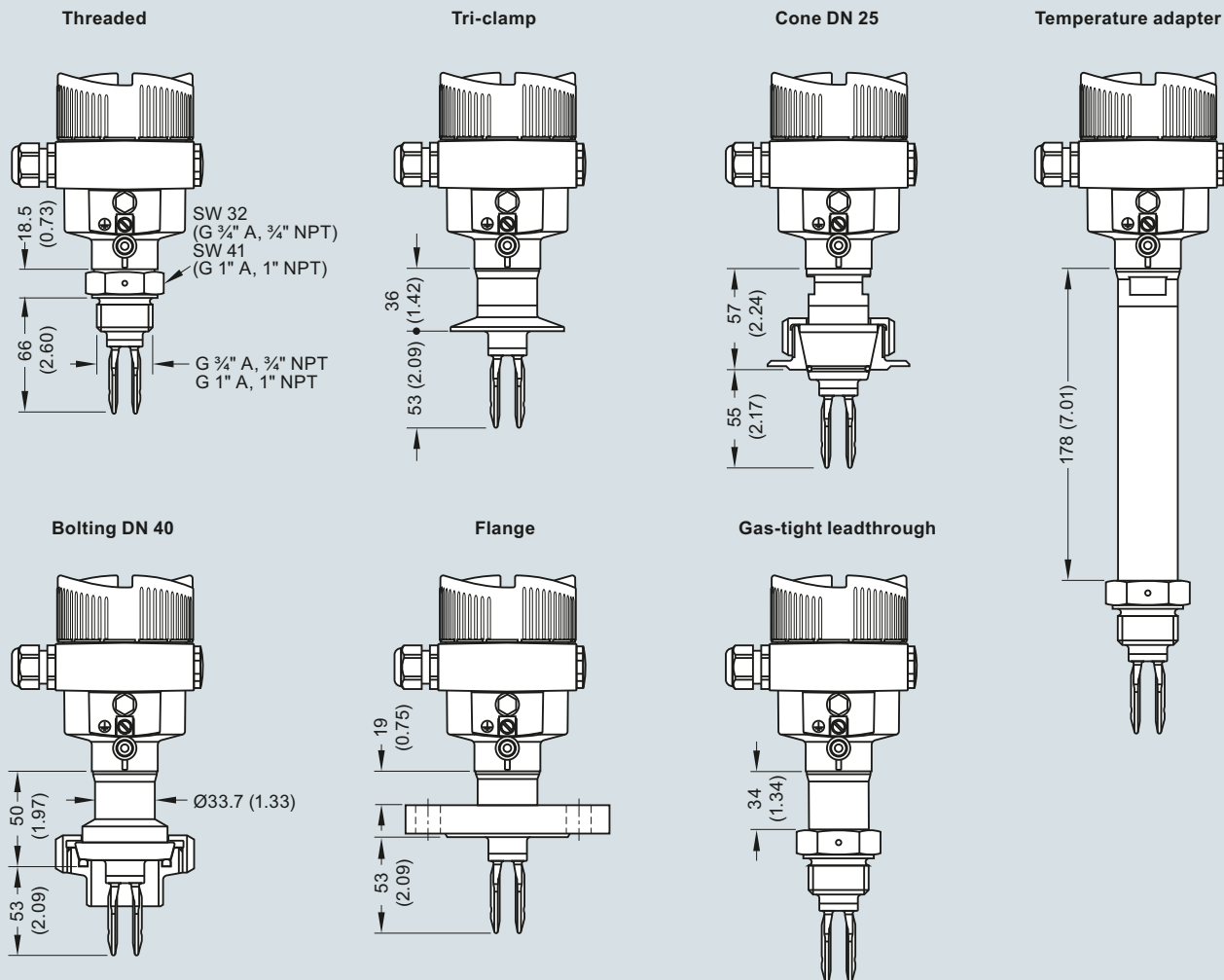

SITRANS LVL200 (standard), dimensions in mm (inch)

SITRANS LVL200 extended

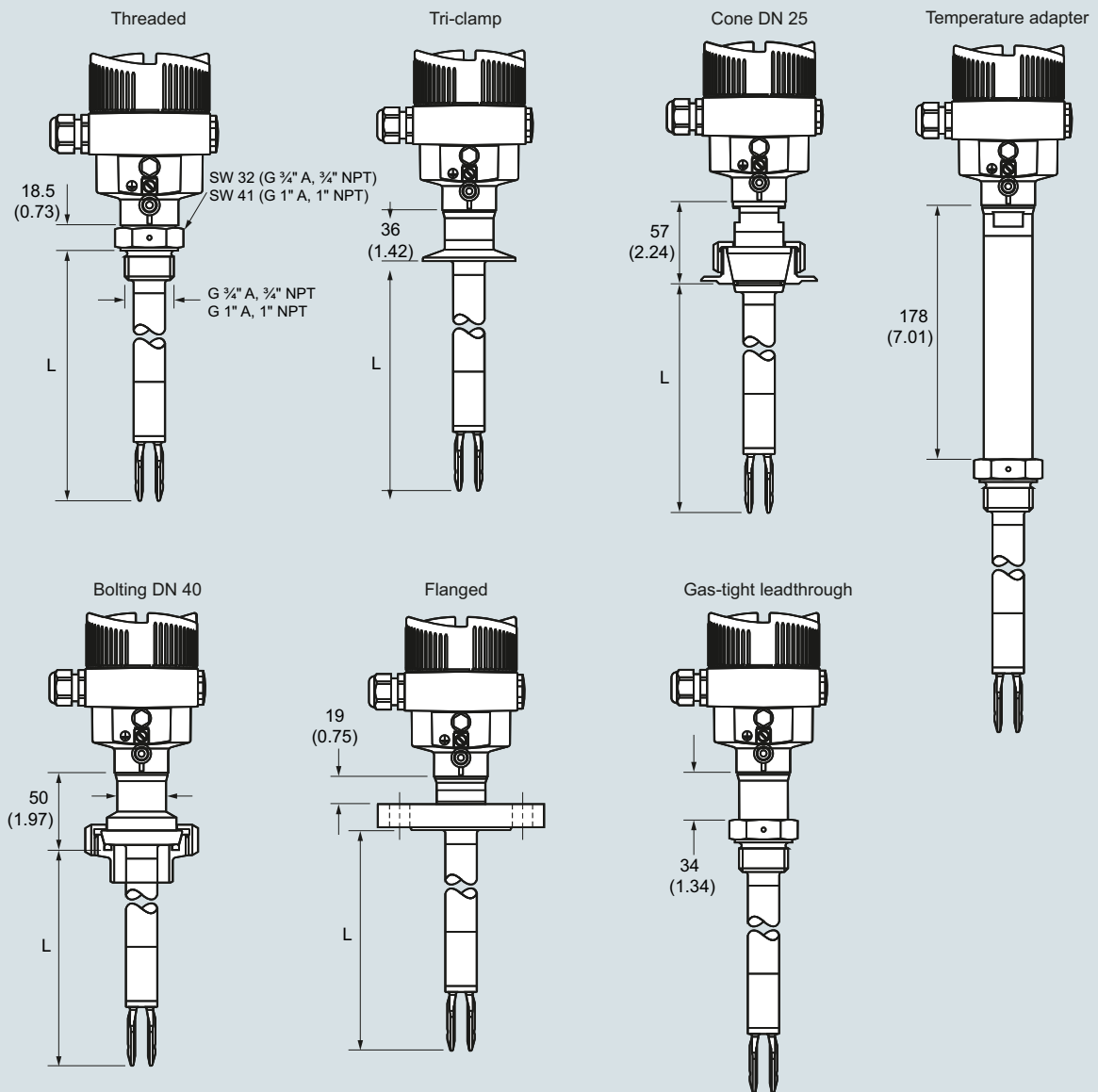

Sensor length (L)

316L, Alloy C22 (2.4602)	80 ... 6 000 mm (3.15 ... 236.2 inch)
Enamelled	80 ... 1 500 mm (3.15 ... 59.06 inch)
316L, ECTFE coated	80 ... 3 000 mm (3.15 ... 118.1 inch)
316L, PFA coated	80 ... 4 000 mm (3.15 ... 157.5 inch)

SITRANS LVL200 (extended), dimensions in mm (inch)

SITRANS LVL200 high temperature, tube version

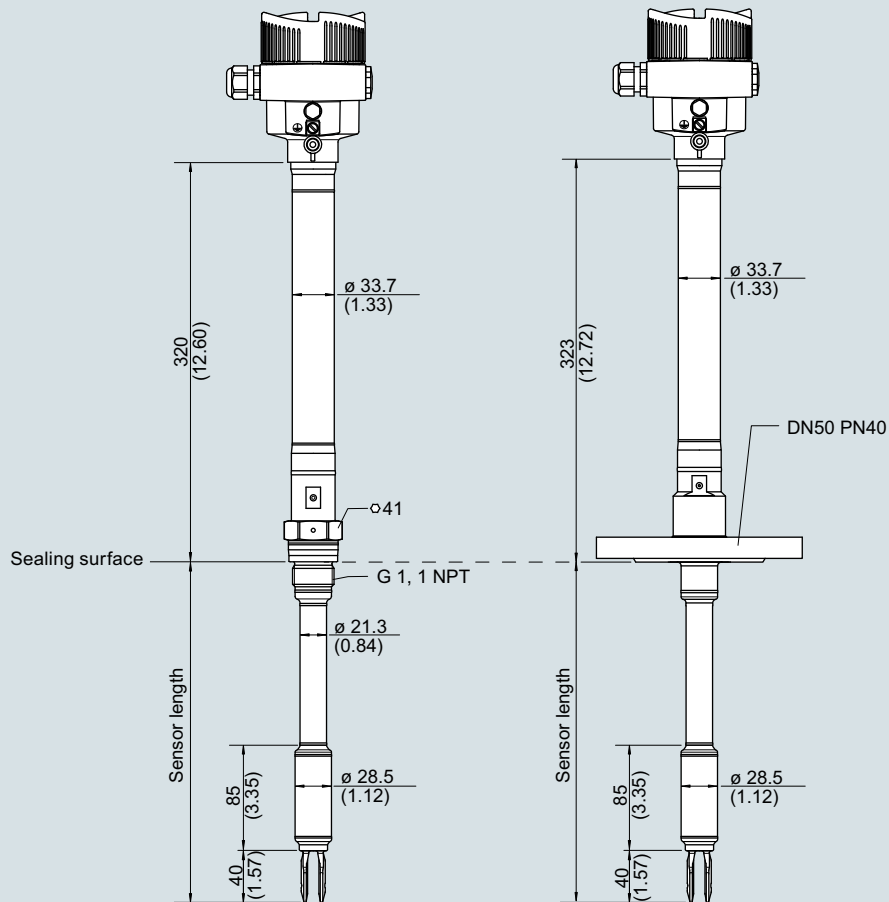

SITRANS LVL200 high temperature (tube version), dimensions in mm (inch)

Level Measurement

Point level measurement
Vibrating switches

SITRANS LVL200

Circuit diagrams

SITRANS LVL200S, LVL200E
Relay (DPDT)

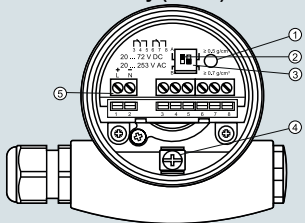

- | | |
|---|---|
| ① | Control lamp |
| ② | DIL switch for characteristics reversal |
| ③ | DIL switch for sensitivity adjustment |
| ④ | Ground terminal |
| ⑤ | Connection terminals |

SITRANS LVL200H
Relay (DPDT)

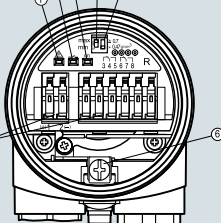

- | | |
|---|---|
| ① | Control lamp - fault indication (red) |
| ② | Control lamp - Switching status (yellow) |
| ③ | Control lamp - Operating status (green) |
| ④ | Mode switch for selecting the switching behaviour (min./max.) |
| ⑤ | DIL switch for sensitivity adjustment |
| ⑥ | Ground terminal |
| ⑦ | Connection terminals |

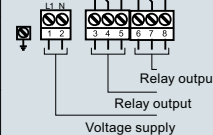

Contactless

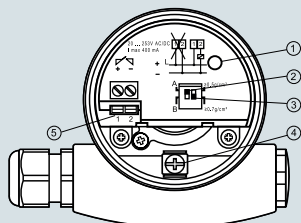

- | | |
|---|---|
| ① | Control lamp |
| ② | DIL switch for mode adjustment |
| ③ | DIL switch for switching point adaptation |
| ④ | Ground terminal |
| ⑤ | Connection terminals |

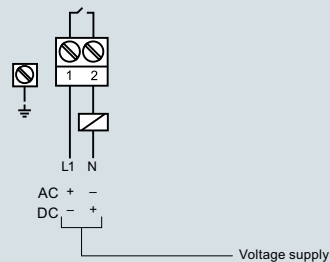

NAMUR

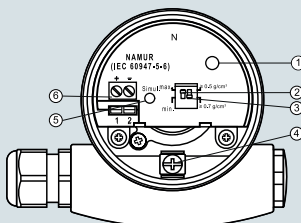

- | | |
|---|---|
| ① | Control lamp |
| ② | DIL switch for characteristics reversal |
| ③ | DIL switch for sensitivity adjustment |
| ④ | Ground terminal |
| ⑤ | Simulation key |
| ⑥ | Connection terminals |

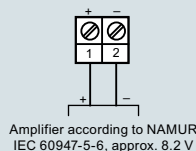

SITRANS LVL200S, LVL200E
Transistor (NPN/PNP)

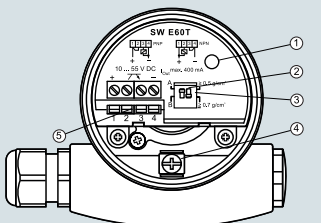

- | | |
|---|--------------------------------|
| ① | Control lamp |
| ② | DIL switch for mode adjustment |
| ③ | DIL switch for switching point |
| ④ | Ground terminal |
| ⑤ | Connection terminals |

SITRANS LVL200H,
Transistor (NPN/PNP)

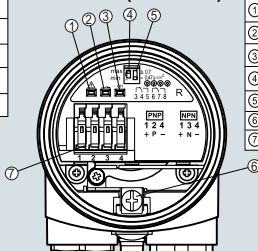

- | | |
|---|---|
| ① | Control lamp - fault indication (red) |
| ② | Control lamp - Switching status (yellow) |
| ③ | Control lamp - Operating status (green) |
| ④ | Mode switch for selecting the switching behaviour (min./max.) |
| ⑤ | DIL switch for sensitivity adjustment |
| ⑥ | Ground terminal |
| ⑦ | Connection terminals |

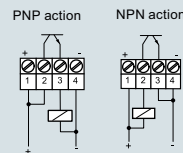

SITRANS LVL200S, LVL200E
8/16 mA

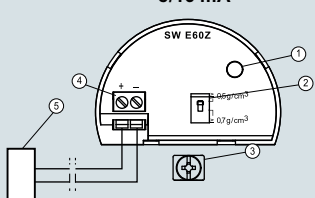

- | | |
|---|---------------------------------------|
| ① | Control lamp |
| ② | DIL switch for sensitivity adjustment |
| ③ | Ground terminal |
| ④ | Connection terminals |
| ⑤ | Processing system or PLC |

SITRANS LVL200H 8/16 mA

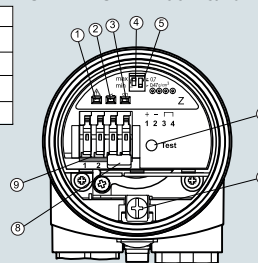

- | | |
|---|--|
| ① | Control lamp - fault indication (red) |
| ② | Control lamp - switching status (yellow) |
| ③ | Control lamp - operating status (green) |
| ④ | Mode switch for selecting the switching behavior (min./max.) |
| ⑤ | DIL switch for sensitivity behavior (min./max.) |
| ⑥ | Test key |
| ⑦ | Ground terminal |
| ⑧ | Connector block |
| ⑨ | Connection terminals |

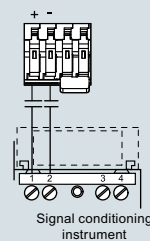

SITRANS LVL200 connections

4