

Overview



The SITRANS F M MAG 3100 is an electromagnetic flow sensor in a large variety that meets the demands of almost every flow application.

Benefits

- Wide range of sizes: DN 15 to DN 2000 (½" to 78")
- The flexible design is for all applications not covered by the standard industry-specific sensors: MAG 1100, MAG 1100 F, MAG 3100 P and MAG 5100 W
- Wide pressure range: PN 6 to PN 100
ANSI Class 150/300, AS 2129, AS 4087, JIS K10 and K20. On request up to 690 bar (10 000 psi)
- Wide range of electrode and liner material to fit even the most extreme process media
- Fully welded construction provides a ruggedness that suits the toughest applications and environments
- Easy commissioning, the SENSORPROM unit automatically updates settings.
- Designed to allow patented SITRANS F M in-situ verification using the SENSORPROM fingerprints.

Application

The main applications of the SITRANS F M electromagnetic flow sensors can be found in the following fields:

- Process industry
- Chemical industry
- Steel industry
- Mining
- Utility
- Power generation and distribution
- Oil and gas / HPI
- Water and waste water

Design

- Compact or remote mounting possible
- Easy "plug & play" field changeability of transmitter
- ATEX and FM/CSA versions
- High temperature sensor for applications with temperatures up to 180 °C (356 °F)
- Meets EEC directives: PED, 2014/68/EU pressure directive for EN1092-1 flanges
- Built-in length according to ISO 13359, the standard includes sizes up to DN 400
- Onsite or factory upgrade to IP68/NEMA 6P of a standard sensor.

Mode of operation

The flow measuring principle is based on Faraday's law of electromagnetic induction according to which the sensor converts the flow into an electrical voltage proportional to the velocity of the flow.

Integration

The complete flowmeter consists of a flow sensor and an associated transmitter MAG 5000, 6000 and 6000 I.

The flexible communication concept USM II simplifies integration and update to a variety of fieldbus systems such as HART, FOUNDATION Fieldbus H1, DeviceNet, PROFIBUS DP and PA, Modbus RTU/RS 485.

Flow Measurement

SITRANS F M

Flow sensor MAG 3100 and MAG 3100 HT

Pressure/temperature curve;
material AISI 316L/1.4404 AS 2129, Class E

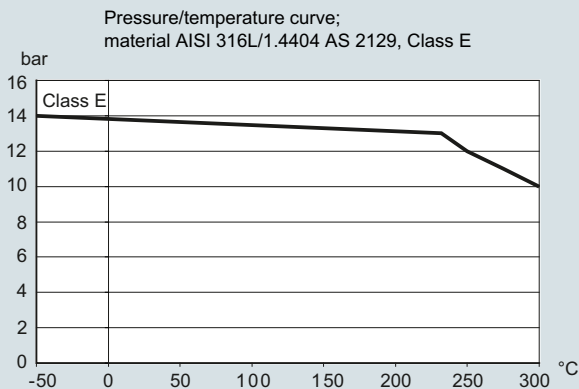

Pressure/temperature curve to EN (DIN) flanges AISI 304

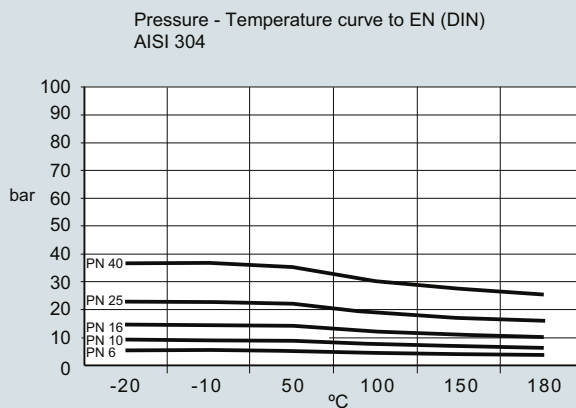

Pressure/temperature curve - JIS 2200

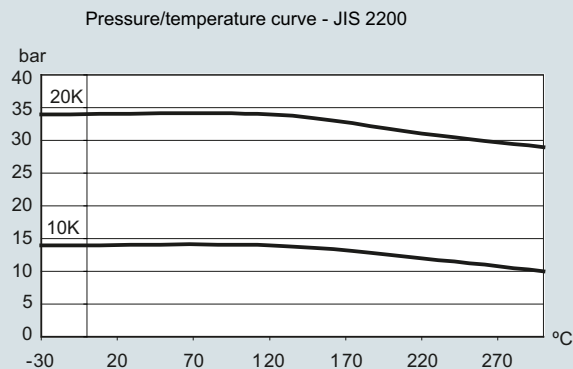

Pressure/temperature curve to EN (DIN) flanges AISI 316

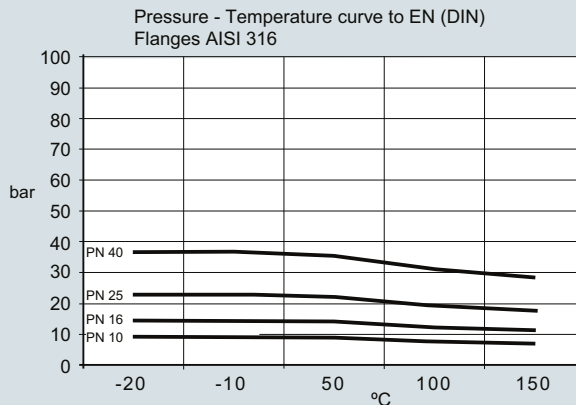

Pressure/temperature curve to EN (DIN) flanges,
material A 105 carbon steel

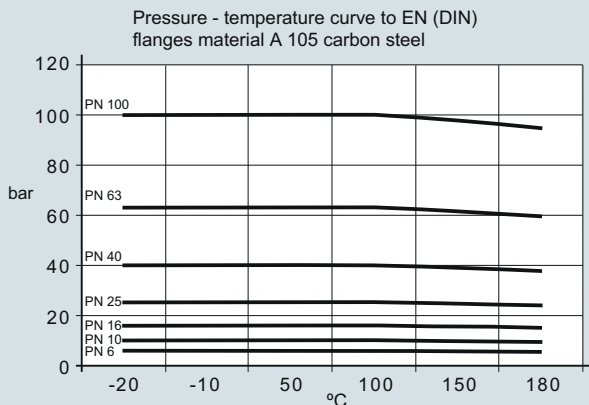

Pressure/temperature curve to ANSI B16.5 flanges

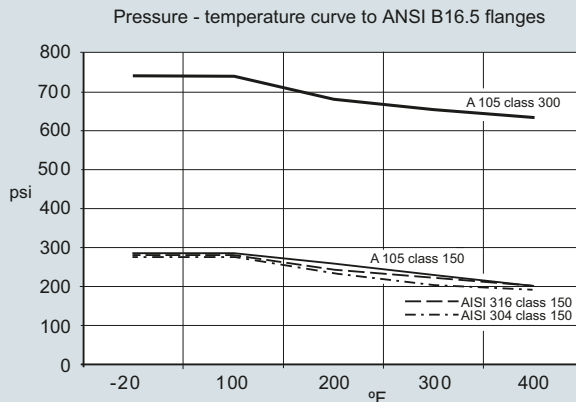

Note: The pressure-temperature curves only assist in the selection of a system. No responsibility is taken for the correctness of the information. For further information on the PED standard and requirements, see page 10/15.

Technical specifications

Version	MAG 3100	MAG 3100 HT (High Temperature)
Product characteristic	Flexible product program	Flexible product program
Nominal size	DN 15 ... DN 2000 (½" ... 78")	DN 15 ... DN 300 (½" ... 12")
Measuring principle	Electromagnetic induction	Electromagnetic induction
Excitation frequency (Mains supply: 50 Hz/60 Hz)	<ul style="list-style-type: none"> • DN 15 ... 65 (½" ... 2½"): 12.5 Hz/15 Hz • DN 80 ... 150 (3" ... 6"): 6.25 Hz/7.5 Hz • DN 200 ... 1200 (8" ... 48"): 3.125 Hz/3.75 Hz • DN 1400 ... 2000 (54" ... 78"): 1.5625 Hz/1.875 Hz 	<ul style="list-style-type: none"> • DN 15 ... 65 (½" ... 2½"): 12.5 Hz/15 Hz • DN 80 ... 150 (3" ... 6"): 6.25 Hz/7.5 Hz • DN 200 ... 300 (8" ... 12"): 3.125 Hz/3.75 Hz
Process connection		
Flanges	<p>EN 1092-1, raised face¹⁾ (EN 1092-1, DIN 2501 and BS 4504 have the same mating dimensions)</p> <ul style="list-style-type: none"> • DN 65 ... 2000 (2½" ... 78"): PN 6 (87 psi) • DN 200 ... 2000 (8" ... 78"): PN 10 (145 psi) • DN 65 ... 2000 (2½" ... 78"): PN 16 (232 psi) • DN 200 ... 600 (8" ... 24"): PN 25 (362 psi) • DN 15 ... 600 (½" ... 24"): PN 40 (580 psi) • DN 50 ... 300 (2" ... 12"): PN 63 (913 psi) • DN 25 ... 300 (1" ... 12"): PN 100 (1450 psi) <p>ANSI B16.5 (~BS 1560), raised face</p> <ul style="list-style-type: none"> • ½" ... 24": Class 150 (20 bar (290 psi)) • ½" ... 24": Class 300 (50 bar (725 psi)) <p>AWWA C-207, flat face 28" ... 78": Class D (10 bar)</p> <p>AS 2129, raised face ½" ... 48": Table E</p> <p>AS 4087, raised face:</p> <ul style="list-style-type: none"> • PN 16 (DN 50 ... 1200, 16 bar (232 psi)) • PN 21 (DN 50 ... 600, 21 bar (304 psi)) • PN 35 (DN 50 ... 600, 35 bar (508 psi)) <p>JIS B 2220:2004</p> <ul style="list-style-type: none"> • K10 (1" ... 24") • K20 (1" ... 24") <p>Other flanges and pressure ratings on request</p>	<p>EN 1092-1, raised face (EN 1092-1, DIN 2501 and BS 4504 have the same mating dimensions)</p> <ul style="list-style-type: none"> • DN 15 ... 300 (½" ... 12"): PN 40 (580 psi) • DN 65 ... 300 (2½" ... 12"): PN 16 (232 psi) • DN 200 ... 300 (8" ... 12"): PN 10 (145 psi) • DN 200 ... 300 (8" ... 12"): PN 25 (362 psi) <p>ANSI B16.5 (~BS 1560), raised face:</p> <ul style="list-style-type: none"> • ½" ... 12": Class 150 (20 bar (290 psi)) • ½" ... 12": Class 300 (50 bar (725 psi)) <p>AS 2129, raised face ½" ... 12": Table E</p> <p>Other flanges and pressure ratings on request</p>
Rated operation conditions		
Ambient temperature (conditions also dependent on liner characteristics)		
<ul style="list-style-type: none"> • Standard sensor • Ex sensor 	<p>-40 ... +100 °C (-40 ... +212 °F)</p> <p>-20 ... +60 °C (-4 ... +140 °F)</p>	<p>-40 ... +100 °C (-40 ... +212 °F)</p> <p>For medium temperature up to 150 °C (302 °F): -20 ... +60 °C (-4 ... +140 °F)</p> <p>For medium temperature 150 ... 180 °C (302 ... 356 °F): -20 ... +50 °C (-4 ... +122 °F)</p>
<ul style="list-style-type: none"> • Compact with transmitter <ul style="list-style-type: none"> - MAG 5000/6000 - MAG 6000 I - MAG 6000 I Ex 	<p>-20 ... +60 °C (-4 ... +140 °F)</p> <p>-20 ... +60 °C (-4 ... +140 °F)</p> <p>-20 ... +60 °C (-4 ... +140 °F)</p>	<p>-20 ... +60 °C (-4 ... +140 °F)</p> <p>-20 ... +60 °C (-4 ... +140 °F)</p> <p>-20 ... +60 °C (-4 ... +140 °F)</p>

Flow Measurement

SITRANS F M

Flow sensor MAG 3100 and MAG 3100 HT

Version	MAG 3100	MAG 3100 HT (High Temperature)
Operating pressure [abs. bar] (maximum operating pressure decreases with increasing operating temperature and with stainless steel flanges)	<ul style="list-style-type: none"> Soft rubber 0.01 ... 100 bar (0.15 ... 1450 psi) EPDM 0.01 ... 40 bar (0.15 ... 580 psi) Linatex 0.01 ... 40 bar (0.15 ... 580 psi) Ebonite 0.01 ... 100 bar (0.15 ... 1450 psi) PTFE <ul style="list-style-type: none"> - DN ≤ 300 (≤ 12"): 0.3 ... 50 bar (4 ... 725 psi) - 350 ≤ DN ≤ 600 (14" ≤ DN ≤ 24"): 0.3 ... 40 bar (4 ... 580 psi) PFA <ul style="list-style-type: none"> - DN 15 ... 150 (½" ... 6"): Vacuum 0.02 ... 50 bar (0.29 ... 725 psi) 	<ul style="list-style-type: none"> PTFE Teflon <ul style="list-style-type: none"> - DN 15 ... 300 (½" ... 12"): 0.3/0.6 ... 50 bar (4/8 ... 725 psi) (180 °C (356 °F)) Factory mounted grounding rings type E in stainless steel and stainless steel terminal box. Can only be used with remote transmitter. PFA <ul style="list-style-type: none"> - DN 15 ... 150 (½" ... 6"): Vacuum 0.02 ... 50 bar (0.29 ... 725 psi)
Enclosure rating	IP67 to EN 60529/NEMA 4X/6, 1 mH ₂ O for 30 min Option: IP68 to EN 60529/NEMA 6P, 10 mH ₂ O cont.	IP67 to EN 60529/NEMA 4X/6, 1 mH ₂ O for 30 min Option: IP68 to EN 60529/NEMA 6P, 10 mH ₂ O cont.
Pressure drop at 3 m/s	As straight pipe	
Test pressure	1.5 x PN (where applicable)	
Mechanical load (vibration)	<ul style="list-style-type: none"> 18 ... 1000 Hz random in x, y, z, directions for 2 hours according to EN 60068-2-36 Sensor: 3.17 g RMS Sensor with compact MAG 5000/ 6000 mounted transmitter: 3.17 g RMS Sensor with compact MAG 6000 I/ 6000 I Ex mounted transmitter: 1.14 g RMS 	<ul style="list-style-type: none"> 18 ... 1000 Hz random in x, y, z, directions for 2 hours according to EN 60068-2-36 Sensor: 3.17 g RMS Sensor with compact MAG 5000/ 6000 mounted transmitter: 3.17 g RMS Sensor with compact MAG 6000 I/ 6000 I Ex mounted transmitter: 1.14 g RMS
Temperature of medium	<ul style="list-style-type: none"> Soft rubber 0 ... +70 °C (32 ... 158 °F) EPDM -10 ... +70 °C (14 ... 158 °F) Linatex (rubber) -40 ... +70 °C (-40 ... +158 °F) (for temperatures below -20 °C (-4 °F) AISI 304 or 316 flanges must be used) Ebonite 0 ... 95 °C (32 ... 203 °F) PTFE -20 ... +100 °C (-4 ... +212 °F) PFA -20 ... +100 °C (-4 ... +212 °F) 	<ul style="list-style-type: none"> PTFE -20 ... +150 °C (-4 ... +302 °F) PTFE -20 ... +180 °C (-4 ... +356 °F) Factory mounted grounding rings type E in stainless steel and stainless steel terminal box. Can only be used with remote transmitter. PFA -20 ... +150 °C (-4 ... +300 °F)
EMC	2014/30/EU	2014/30/EU
Design		
Weight	See dimensional drawings	
Flange and housing material	Carbon steel ASTM A 105, with corrosion resistant coating Corrosivity category C4, according to ISO 12944-2 or Stainless steel AISI 304/1.4301 flanges and carbon steel housing, with corrosion resistant coating Corrosivity category C4, according to ISO 12944-2 or Stainless steel AISI 316L/1.4404 flanges and housing, polished	Carbon steel ASTM A 105, with corrosion resistant coating Corrosivity category C4, according to ISO 12944-2 or Stainless steel AISI 304/1.4301 flanges and carbon steel housing, with corrosion resistant coating Corrosivity category C4, according to ISO 12944-2 or Stainless steel AISI 316L/1.4404 flanges and housing, polished
Electrode material	<ul style="list-style-type: none"> Stainless steel AISI 316Ti/1.4571 Hastelloy C276/2.4819 (PFA: Hastelloy C22/2.4602) Platinum/Iridium Titanium Tantalum 	<ul style="list-style-type: none"> Stainless steel AISI 316Ti/1.4571 Hastelloy C276/2.4819 (PFA: Hastelloy C22/2.4602) Platinum/Iridium Titanium Tantalum
Grounding electrode material	<ul style="list-style-type: none"> Soft rubber, EPDM, Linatex, Ebonite: available with grounding electrodes in stainless steel AISI 316Ti/1.4571 or Hastelloy PTFE: no grounding electrodes PFA: optional in Hastelloy, Tantalum or Platinum 	<ul style="list-style-type: none"> PTFE: no grounding electrodes PFA: optional in Hastelloy, Tantalum or Platinum

Version	MAG 3100	MAG 3100 HT (High Temperature)
Design (continued)		
Terminal box (remote version only)	<ul style="list-style-type: none"> Standard fibre glass reinforced polyamide Option Stainless steel AISI 316/1.4436 Ex Stainless steel AISI 316/1.4436 	<ul style="list-style-type: none"> Standard fibre glass reinforced polyamide (max. 150 °C (302 °F)) Stainless steel AISI 316/1.4436 Ex Stainless steel AISI 316/1.4436
Cable entries	<ul style="list-style-type: none"> Remote installation 2 x M20 or 2 x ½" NPT Compact installation <ul style="list-style-type: none"> MAG 5000/MAG 6000: 4 x M20 or 4 x ½" NPT MAG 6000 I: 2 x M25 or 2 x ½" NPT (for supply/output) MAG 6000 I Ex: 2 x M25 or 2 x ½" NPT (for supply/output) 	<ul style="list-style-type: none"> Remote installation 2 x M20 or 2 x ½" NPT
Certificates and approvals		
Calibration		
<ul style="list-style-type: none"> Standard production calibration Special calibration 	Zero-point, 2 x 25 % and 2 x 90 % 5-point calibration: 20 %, 40 %, 60 %, 80 %, 100 % of factory Q _{max} 10-point calibration: ascending and descending at 20 %, 40 %, 60 %, 80 %, 100 % of factory Q _{max} Matched-pair calibration: default, 5-point or 10-point	Zero-point, 2 x 25 % and 2 x 90 %
Hazardous areas ²⁾		
<ul style="list-style-type: none"> Ex sensor in compact or remote version with MAG 6000 I Ex 	ATEX, FM, CSA, IECEx, EAC Ex, NEPSI - Zone 1 Ex d e ia IIC T6 Gb ⁴⁾ - Zone 1 Ex e ia IIC T6 Gb ⁵⁾ ATEX, FM, CSA, IECEx - Zone 21 Ex tD A21 IP67 FM - XP IS Class I Div. 1 Groups A, B, C, D ⁶⁾ - DIP Class II+III Div. 1 Groups E, F, G ⁶⁾	ATEX, FM, CSA, IECEx, EAC Ex - Zone 1 Ex d e ia IIC T6 Gb ⁴⁾ - Zone 1 Ex e ia IIC T6 Gb ⁵⁾ ATEX, FM, CSA, IECEx - Zone 21 Ex tD A21 IP67 FM - XP IS Class I Div. 1 Groups A, B, C, D ⁶⁾ - DIP Class II+III Div. 1 Groups E, F, G ⁶⁾
<ul style="list-style-type: none"> Standard sensor with/without MAG 5000/6000/6000 I 	FM - NI Class I Div. 2 Groups A, B, C, D - NI Class I Zone 2 Groups IIC	FM - NI Class I Div. 2 Groups A, B, C, D - NI Class I Zone 2 Groups IIC
Drinking water	EPDM liner: <ul style="list-style-type: none"> WRAS (WRc, BS690 cold water, GB) NSF/ANSI Standard 61⁷⁾ (Cold water, US) ACS listed (F) DVGW W270 (D) Belgaqua (B) MCERTS (GB) (EPDM or PTFE lining with AISI 316 or Hastelloy electrodes) 	
Pressure equipment	<ul style="list-style-type: none"> PED conforming: All EN 1092-1 flanges - 2014/68/EU³⁾ CRN 	<ul style="list-style-type: none"> PED conforming: All EN 1092-1 flanges - 2014/68/EU³⁾ CRN
Others	<ul style="list-style-type: none"> EAC (Russia, Belarus, Kazakhstan) KCC (South Korea) CMC/CPA (China) 	<ul style="list-style-type: none"> EAC (Russia, Belarus, Kazakhstan) KCC (South Korea)

Technical specification for transmitter - see transmitter pages.

¹⁾ PN 6-40: DN ≤ 600 type 01 (SORF); DN > 600 type 11 (WNRF); PN 63-100: type 11 (WNRF)

²⁾ Not for sensor with 300 µm coating.

³⁾ For sizes larger than 600 mm (24") in PN 16 PED conformity is available as a cost-added option. The basic unit will carry the LVD (Low Voltage Directive) and EMC approval. All products sold outside of EU and EFTA are excluded from the Pressure Equipment directive, also products sold into certain market sectors are excluded. These include:

a) Meters used in networks for the supply, distribution and discharge of water.

b) Meters used in pipelines for the conveyance of any fluid from offshore to onshore.

c) Meters used in the extraction of petroleum or gas, including christmas tree and manifold equipment.

d) Any meter mounted on a ship or mobile offshore platform. For further information on the PED standard and requirements see page 10/15.

⁴⁾ In remote version with sensor size DN 15 ... DN 300 (½" ... 12")

⁵⁾ In remote version with sensor size DN 350 ... DN 2000 (14" ... 78")

⁶⁾ In compact version with sensors size DN 15 ... 300 (½" ... 12").

⁷⁾ Including Annex G

Flow Measurement

SITRANS F M

Flow sensor MAG 3100 and MAG 3100 HT

Selection and Ordering data	Article No.
Sensor SITRANS F M MAG 3100	7ME6310-
	
↗ Click on the Article No. for the online configuration in the PIA Life Cycle Portal.	
Diameter	
DN 15 (½") (PTFE and PFA liner)	1 V
DN 25 (1")	2 D
DN 40 (1½")	2 R
DN 50 (2")	2 Y
DN 65 (2½")	3 F
DN 80 (3")	3 M
DN 100 (4")	3 T
DN 125 (5")	4 B
DN 150 (6")	4 H
DN 200 (8")	4 P
DN 250 (10")	4 V
DN 300 (12")	5 D
DN 350 (14")	5 K
DN 400 (16")	5 R
DN 450 (18")	5 Y
DN 500 (20")	6 F
DN 600 (24")	6 P
DN 700 (28")	6 Y
DN 750 (30") (AWWA and AS 2129 only)	7 D
DN 800 (32")	7 H
DN 900 (36")	7 M
DN 1000 (40")	7 R
DN 1050 (42") (AWWA only)	7 U
DN 1100 (44") (AWWA only)	7 V
DN 1200 (48")	8 B
DN 1400 (54")	8 F
DN 1500 (60")	8 K
DN 1600 (66")	8 P
DN 1800 (72")	8 T
DN 2000 (78")	8 Y
Flange norm and pressure rating	
<u>EN 1092-1</u>	
PN 6 (DN 65 ... 2000 (2½" ... 78"))	A
PN 10 (DN 200 ... 2000 (8" ... 78"))	B
PN 16 (DN 65 ... 1200 (2½" ... 48"))	C
PN 16, non-PED (DN 700 ... 2000 (28" ... 78"))	D
PN 25 (DN 200 ... 600 (8" ... 24"))	E
PN 40 (DN 15 ... 600 (½" ... 24"))	F
PN 63 (DN 50 ... 300 (2" ... 12"))	G
PN 100 (DN 25 ... 300 (1" ... 12"))	H
<u>ANSI B16.5</u>	
Class 150 (½" ... 24")	J
Class 300 (½" ... 24")	K
<u>AWWA C-207</u>	
Class D (28" ... 78")	L
<u>AS</u>	
2129, table E	M
4087, PN 16 (DN 50 ... 1200 (2" ... 48")) (Not PTFE and PFA)	N
4087, PN 21 (DN 50 ... 600 (2" ... 24")) (Not PTFE and PFA)	P
4087, PN 35 (DN 50 ... 600 (2" ... 24")) (Not PTFE and PFA)	Q
<u>JIS B 2220:2004</u>	
K10 (1" ... 24")	R
K20 (1" ... 24")	S

Selection and Ordering data	Article No.
Sensor SITRANS F M MAG 3100	7ME6310-
	
Flange material and coating	
Carbon steel flanges ASTM A 105, corrosion-resistant coating of category C4	1
Stainless steel flanges, AISI 304/1.4301, corrosion-resistant coating of category C4	2
Stainless steel flanges and sensor body, AISI 316L/1.4404, polished	3
Carbon steel flanges ASTM A 105, 300 µm corrosion-resistant coating of category C4	4
Stainless steel flanges, AISI 304/1.4301, 300 µm corrosion-resistant coating of category C4	5
Liner material	
Soft rubber	1
EPDM	2
PTFE (DN ≤ 300, PN ≤ 50 bar / ≤ 12", PN ≤ 725 psi), PTFE (350 ≤ DN ≤ 600, PN ≤ 40 bar / 14" ≤ DN ≤ 24", PN ≤ 580 psi)	3
Ebonite	4
Linatex (PN ≤ 40 bar (580 psi) DN ≤ 600 (24"))	5
PFA (DN 15 ... 150 (½" ... 6")) (PN ≤ 40 bar (580 psi))	7
Electrode material	
(Grounding electrodes not for PTFE liner or pressure rating PN 100)	
AISI 316Ti/1.4571 (not for PFA)	1
Hastelloy C276/2.4819 (PFA liner: Hastelloy C22/2.4602)	2
Platinum (DN ≤ 300 (12")) (not for Ebonite)	3
Titanium (not for PFA) (DN ≤ 600/24")	4
Tantalum (DN ≤ 600/24") (not for Ebonite)	5
Hastelloy C incl. grounding electrodes (only PFA)	6
Platinum incl. grounding electrodes (only PFA)	7
Tantalum incl. grounding electrodes (only PFA)	8
Transmitter with display	
Standard sensor for remote transmitter (order transmitter separately)	A
Ex sensor for remote transmitter (order transmitter separately)	B
MAG 6000 I, Alu.18 ... 90 V DC, 115 ... 230 V AC	C
MAG 6000 I Alu. 18 ... 30 V DC, Ex	D
MAG 6000 I Alu. 115 ... 230 V, Ex	E
MAG 6000 Polyamide, 11... 30 V DC / 11...24 V AC	H
MAG 6000, Polyamide, 115 ... 230 V AC	J
MAG 5000, Polyamide, 11... 30 V DC / 11...24 V AC	K
MAG 5000, Polyamide, 115 ... 230 V AC	L
Communication	
No communication, add-on possible	A
HART	B
PROFIBUS PA Profile 3 (only MAG 6000/MAG 6000 I)	F
PROFIBUS DP Profile 3 (not for Ex) (only MAG 6000/MAG 6000 I)	G
Modbus RTU/RS 485 (not for Ex) (only MAG 6000/MAG 6000 I)	E
FOUNDATION Fieldbus H1 (only MAG 6000/MAG 6000 I)	J
Cable glands/terminal box	
Metric: Polyamide terminal box or MAG 6000 I compact	1
½" NPT: Polyamide terminal box or MAG 6000 I compact	2
Metric: Stainless steel terminal box	3

Selection and Ordering data	Order code
Additional information	
Please add “-Z” to Article No. and specify Order code(s) and plain text.	
Certificates	
• Pressure test certificate according to EN 10204-3.1	C01
• Material certificate according to EN 10204-3.1	C12
• Factory certificate according to EN 10204-2.2	C14
• Factory certificate according to EN 10204-2.1	C15
Special calibration	
• 5-point calibration for DN 15 ... DN 200 ¹⁾	D01
• 5-point calibration for DN 250 ... DN 600 ¹⁾	D02
• 5-point calibration for DN 700 ... DN 1200 ¹⁾	D03
• 10-point calibration for DN 15 ... DN 200 ²⁾	D06
• 10-point calibration for DN 250 ... DN 600 ²⁾	D07
• 10-point calibration for DN 700 ... DN 1200 ²⁾	D08
• Default (2 x 25 % and 2 x 90 %) match-pair calibration for DN 15 ... DN 200	D11
• Default (2 x 25 % and 2 x 90 %) match-pair calibration for DN 250 ... DN 600	D12
• Default (2 x 25 % and 2 x 90 %) match-pair calibration for DN 700 ... DN 1200	D13
• 5-point, matched-pair calibration for DN 15 ... DN 200 ¹⁾	D15
• 5-point, matched-pair calibration for DN 250 ... DN 600 ¹⁾	D16
• 5-point, matched-pair calibration for DN 700 ... DN 1200 ¹⁾	D17
• 10-point, matched-pair calibration for DN 15 ... DN 200 ²⁾	D18
• 10-point, matched-pair calibration for DN 250 ... DN 600 ²⁾	D19
• 10-point, matched-pair calibration for DN 700 ... DN 1200 ²⁾	D20
Terminal blocks	
• Factory mounted terminal blocks	N02
Region/customer specific labels	
• Chinese label	W06
• KCC label (South Korea)	W28
Tag name plate, stainless steel (specify in plain text)	Y17
Tag name plate, plastic (self adhesive)	Y18
Customer-specific transmitter setting	Y20
Sensor cables wired (specify Article No. for sensor cables and order cables separately)	Y40
Sensor cables wired and IP68 sealing (specify Article No. for sensor cables and order cables separately)	Y41
Special version (specify in plain text)	Y99
Additional calibrations	
• Accredited Siemens Flow Instruments matched pair Calibration acc. to ISO/IEC 17025: 2005	On request³⁾
• Customer-specified calibration up to 10 points	On request³⁾
• Customer-witnessed calibration Any of above calibration	On request³⁾

¹⁾ 20 %, 40 %, 60 %, 80 %, 100 % of factory Q_{max}

²⁾ Ascending and descending at 20 %, 40 %, 60 %, 80 %, 100 % of factory Q_{max}

³⁾ Product Variation Request (PVR).

Operating instructions for SITRANS F M MAG 3100

Description	Article No.
• English	A5E03005599
• German	A5E03086288

All literature is available to download for free, in a range of languages, at www.siemens.com/processinstrumentation/documentation

Accessories

Description	Article No.
Potting kit for IP68/ NEMA 6P sealing of sensor junction box	FDK:085U0220



Please use online Product selector to get latest updates.

Product selector link:

www.pia-portal.automation.siemens.com

Flow Measurement

SITRANS F M

Flow sensor MAG 3100 and MAG 3100 HT

3

Selection and Ordering data	Article No.
Sensor SITRANS F M MAG 3100 HT (High Temperature)	7 ME 6 3 2 0 -
Click on the Article No. for the online configuration in the PIA Life Cycle Portal.	
Diameter	
DN 15 (½")	1 V
DN 25 (1")	2 D
DN 40 (1½")	2 R
DN 50 (2")	2 Y
DN 65 (2½")	3 F
DN 80 (3")	3 M
DN 100 (4")	3 T
DN 125 (5")	4 B
DN 150 (6")	4 H
DN 200 (8")	4 P
DN 250 (10")	4 V
DN 300 (12")	5 D
Flange norm and pressure rating	
EN 1092-1	
PN 10 (DN 200 ... 300 (8" ... 12"))	B
PN 16 (DN 65 ... 300 (2½" ... 12"))	C
PN 25 (DN 200 ... 300 (8" ... 12"))	E
PN 40 (DN 15 ... 300 (½" ... 12"))	F
ANSI B16.5	
Class 150 (½" ... 12")	J
Class 300 (½" ... 12")	K
AS	
2129, table E	M
Flange material	
Carbon steel flanges ASTM A 105	1
Stainless steel flanges, AISI 304/1.4301	2
Stainless steel flanges and sensor body, AISI 316L/1.4404, polished	3
Liner material	
PTFE (150 °C (302 °F))	2
PTFE including type E protection rings	3
AISI 316/1.4436 (180 °C (356 °F))	
PFA (150 °C (302 °F)) (DN 15 ... 150 (½" ... 6"))	7
Electrode material	
AISI 316Ti/1.4571 (not for PFA)	1
Hastelloy C276/2.4819	2
(PFA liner: Hastelloy C22/2.4602)	
Platinum	3
Titanium (not for PFA)	4
Tantalum	5
Hastelloy C22/2.4602 incl. grounding electrodes (only PFA)	6
Platinum incl. grounding electrodes (only PFA)	7
Tantalum incl. grounding electrodes (only PFA)	8
Transmitter with display	
Standard sensor for remote transmitter (Order transmitter separately)	A
Ex sensor for remote transmitter (Order transmitter separately)	B
MAG 6000 I, Alu. 18 ... 90 V DC, 115 ... 230 V AC	C
MAG 6000 I, Alu. 18 ... 30 V DC, Ex	D
MAG 6000 I, Alu. 115 ... 230 V AC, Ex	E
MAG 6000, Polyamide, 11 ... 30 V DC/11 ... 24 V AC	H
MAG 6000, Polyamide, 115 ... 230 V AC	J
MAG 5000, Polyamide, 11 ... 30 V DC/11 ... 24 V AC	K
MAG 5000, Polyamide, 115 ... 230 V AC	L

Selection and Ordering data	Article No.
Sensor SITRANS F M MAG 3100 HT (High Temperature)	7 ME 6 3 2 0 -
Communication	
No communication, add-on possible	A
HART	B
PROFIBUS PA Profile 3 (only MAG 6000/MAG 6000 I)	F
PROFIBUS DP Profile 3 (only MAG 6000/MAG 6000 I)	G
Modbus RTU/RS 485 (only MAG 6000/MAG 6000 I)	E
FOUNDATION Fieldbus H1 (only MAG 6000/MAG 6000 I)	J
Cable glands/terminal box	
Metric: Polyamide terminal box (PTFE 130 °C (266 °F)) or MAG 6000 I compact	1
½" NPT: Polyamide terminal box (PTFE 130 °C (266 °F)) or MAG 6000 I compact	2
Metric: Stainless steel terminal box	3
½" NPT: Stainless steel terminal box	4

Selection and Ordering data	Order code
Additional information	
Please add "-Z" to Article No. and specify Order code(s) and plain text.	
Certificates	
• Pressure test certificate according to EN 10204-3.1	C01
• Material certificate according to EN 10204-3.1	C12
• Factory certificate according to EN 10204-2.2	C14
• Factory certificate according to EN 10204-2.1	C15
Terminal blocks	
• Factory mounted terminal blocks	N02
Region/customer specific labels	
• KCC label (South Korea)	W28
Tag name made, stainless steel (specify in plain text)	Y17
Tag name plate, plastic (self adhesive)	Y18
Customer-specific transmitter setting	Y20
Sensor cables wired (specify Article No. for sensor cables and order cables separately)	Y40
Sensor cables wired and IP68 sealing (specify Article No. for sensor cables and order cables separately)	Y41
Special version (specify in plain text)	Y99
Additional calibrations	
• Matched pair - (Standard production calibration where sensor and transmitter is calibrated together)	On request¹⁾
• Accredited Siemens Flow Instruments matched pair Calibration acc. to ISO/IEC 17025: 2005	On request¹⁾
• Customer-specified calibration up to 10 points	On request¹⁾
• Customer-witnessed calibration Any of above calibration	On request¹⁾

¹⁾ Product Variation Request (PVR).

Accessories for MAG 3100 and MAG 3100 HT sensor**Grounding and protection ring - Type C (Stainless steel)¹⁾**

Material AISI 304
For all liners except PTFE and PFA
1 pc.

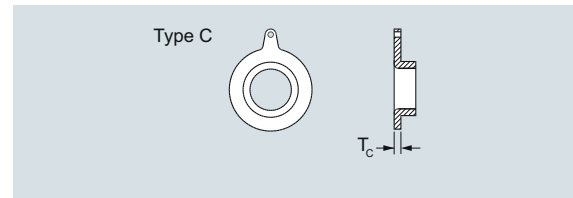

DN	PN 6 Article No.	PN 10 Article No.	PN 16 Article No.	PN 25 Article No.	PN 40 Article No.	AS 2129 Table E Article No.
DN 25 DN 40 DN 50					FDK:083N8361 FDK:083N8362 FDK:083N8344	FDK:083N8361 FDK:083N8362 FDK:083N8344
DN 65 DN 80 DN 100	FDK:083N8345 FDK:083N8347 FDK:083N8070		FDK:083N8345 FDK:083N8347 FDK:083N8025		FDK:083N8345 FDK:083N8347 FDK:083N8025	FDK:083N8346 FDK:083N8347 FDK:083N8025
DN 125 DN 150 DN 200	FDK:083N8071 FDK:083N8072 FDK:083N8074	FDK:083N8011	FDK:083N8071 FDK:083N8008 FDK:083N8011	FDK:083N8011	FDK:083N8071 FDK:083N8073 FDK:083N8075	FDK:083N8071 FDK:083N8008 FDK:083N8011
DN 250 DN 300 DN 350	FDK:083N8078 FDK:083N8080 FDK:083N8083	FDK:083N8013 FDK:083N8012 FDK:083N8039	FDK:083N8013 FDK:083N8012 FDK:083N8039	FDK:083N8013 FDK:083N8081 FDK:083N8084	FDK:083N8079 FDK:083N8082 FDK:083N8085	FDK:083N8013 FDK:083N8012 FDK:083N8039
DN 400 DN 450 DN 500	FDK:083N8099 FDK:083N8103 FDK:083N8107	FDK:083N8100 FDK:083N8103 FDK:083N8107	FDK:083N8100 FDK:083N8104 FDK:083N8108	FDK:083N8101 FDK:083N8104 FDK:083N8108	FDK:083N8102 FDK:083N8105 FDK:083N8109	FDK:083N8100 FDK:083N8104 FDK:083N8108
DN 600 DN 700 DN 750	FDK:083N8111 FDK:083N8300	FDK:083N8111 FDK:083N8294	FDK:083N8112 FDK:083N8294	FDK:083N8112		FDK:083N8113 FDK:083N8372
DN 800 DN 900 DN 1000	FDK:083N8303 FDK:083N8306 FDK:083N8309	FDK:083N8304 FDK:083N8307 FDK:083N8310	FDK:083N8304 FDK:083N8307 FDK:083N8310			FDK:083N8373 FDK:083N8396 FDK:083N8397
DN 1100 DN 1200 DN 1400		FDK:083N8367 FDK:083N8313 FDK:083N8468	FDK:083N8367 FDK:083N8313 FDK:083N8469			FDK:083N8367 FDK:083N8398
DN 1500 DN 1600 DN 1800 DN 2000	FDK:083N8471 FDK:083N8475 FDK:083N8479 FDK:083N8483	FDK:083N8472 FDK:083N8476 FDK:083N8480 FDK:083N8484	FDK:083N8473 FDK:083N8477 FDK:083N8481 FDK:083N8485			

¹⁾ Also for MAG 5100 W (7ME6520 > DN 300 and 7ME6580)

Size	ANSI Class 150 Article No.	Class 300 Article No.	JIS K10 Article No.	JIS K20 Article No.	Size	AWWA C-207 Article No.
1"	FDK:083N8361	FDK:083N8361	FDK:083N8361	FDK:083N8361	28"	FDK:083N8302
1½"	FDK:083N8362	FDK:083N8362	FDK:083N8362	FDK:083N8362	30"	FDK:083N8366
2"	FDK:083N8344	FDK:083N8344	FDK:083N8344	FDK:083N8344	32"	FDK:083N8305
2½"	FDK:083N8345	FDK:083N8345	FDK:083N8345	FDK:083N8345	36"	FDK:083N8308
3"	FDK:083N8347	FDK:083N8347	FDK:083N8347	FDK:083N8347	40"	FDK:083N8311
4"	FDK:083N8025	FDK:083N8025	FDK:083N8070	FDK:083N8025	42"	FDK:083N8394
5"	FDK:083N8071	FDK:083N8071	FDK:083N8071	FDK:083N8071	44"	FDK:083N8395
6"	FDK:083N8008	FDK:083N8073	FDK:083N8008	FDK:083N8008	48"	FDK:083N8314
8"	FDK:083N8011	FDK:083N8076	FDK:083N8011	FDK:083N8011	54"	FDK:083N8470
10"	FDK:083N8013	FDK:083N8079	FDK:083N8013	FDK:083N8079	60"	FDK:083N8474
12"	FDK:083N8012	FDK:083N8082	FDK:083N8012	FDK:083N8081	66"	FDK:083N8478
14"	FDK:083N8039	FDK:083N8085	FDK:083N8083	FDK:083N8039	72"	FDK:083N8482
16"	FDK:083N8100	FDK:083N8102	FDK:083N8100	FDK:083N8101	78"	FDK:083N8486
18"	FDK:083N8104	FDK:083N8106	FDK:083N8103	FDK:083N8104		
20"	FDK:083N8107	FDK:083N8110	FDK:083N8107	FDK:083N8108		
24"	FDK:083N8113	FDK:083N8114	FDK:083N8111	FDK:083N8112		

¹⁾ Also for MAG 5100 W (7ME6520 > 12 inch and 7ME6580)

Flow Measurement

SITRANS F M

Flow sensor MAG 3100 and MAG 3100 HT

Accessories for MAG 3100 and MAG 3100 HT sensor

Grounding and protecting ring - Type E (Stainless steel)

Material: AISI 316
For all PTFE liners
1 pc. incl. straps and screws

Note:

For MAG 3100 HT High temperature version 7ME6320... for PTFE 180 °C (356 °C) versions - grounding ring type E is included and factory mounted.

Type E

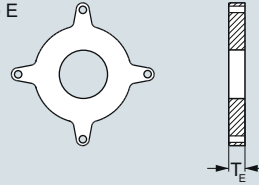

DN	PN 6 Article No.	PN 10 Article No.	PN 16 Article No.	PN 25 Article No.	PN 40 Article No.
DN 15 DN 25 DN 40					FDK:083N8365 FDK:083N8271 FDK:083N8278
DN 50 DN 65 DN 80	FDK:083N8284 FDK:083N8288		FDK:083N8285 FDK:083N8289		FDK:083N8282 FDK:083N8286 FDK:083N8290
DN 100 DN 125 DN 150	FDK:083N8116 FDK:083N8120 FDK:083N8124		FDK:083N8117 FDK:083N8121 FDK:083N8125		FDK:083N8118 FDK:083N8122 FDK:083N8126
DN 200 DN 250 DN 300	FDK:083N8129 FDK:083N8135 FDK:083N8144	FDK:083N8130 FDK:083N8136 FDK:083N8144	FDK:083N8130 FDK:083N8137 FDK:083N8145	FDK:083N8131 FDK:083N8138 FDK:083N8146	FDK:083N8132 FDK:083N8139 FDK:083N8147
DN 350 DN 400 DN 450	FDK:083N8152 FDK:083N8160 FDK:083N8168	FDK:083N8153 FDK:083N8161 FDK:083N8169	FDK:083N8154 FDK:083N8162 FDK:083N8170	FDK:083N8155 FDK:083N8163 FDK:083N8171	FDK:083N8156 FDK:083N8164 FDK:083N8172
DN 500 DN 600	FDK:083N8177 FDK:083N8186	FDK:083N8178 FDK:083N8187	FDK:083N8179 FDK:083N8188	FDK:083N8180 FDK:083N8189	FDK:083N8181

For use as protection ring order 2 pcs.
For use as grounding ring order 1 pc.

Size	ANSI			
	Class 150 Article No.	Class 300 Article No.	JIS K10 Article No.	JIS K20 Article No.
½"	FDK:083N8365	FDK:083N8365		
1"	FDK:083N8272	FDK:083N8272	FDK:083N8271	FDK:083N8271
1½"	FDK:083N8279	FDK:083N8279	FDK:083N8278	FDK:083N8278
2"	FDK:083N8283	FDK:083N8283	FDK:083N8282	FDK:083N8282
2½"	FDK:083N8287	FDK:083N8287	FDK:083N8285	FDK:083N8285
3"	FDK:083N8291	FDK:083N8292	FDK:083N8288	FDK:083N8289
4"	FDK:083N8118	FDK:083N8119	FDK:083N8116	FDK:083N8117
5"	FDK:083N8122	FDK:083N8123	FDK:083N8121	FDK:083N8122
6"	FDK:083N8126	FDK:083N8127	FDK:083N8125	FDK:083N8126
8"	FDK:083N8370	FDK:083N8133	FDK:083N8130	FDK:083N8370
10"	FDK:083N8140	FDK:083N8141	FDK:083N8137	FDK:083N8139
12"	FDK:083N8148	FDK:083N8149	FDK:083N8144	FDK:083N8146
14"	FDK:083N8157	FDK:083N8158	FDK:083N8152	FDK:083N8154
16"	FDK:083N8165	FDK:083N8166	FDK:083N8160	FDK:083N8165
18"	FDK:083N8173	FDK:083N8174	FDK:083N8169	FDK:083N8171
20"	FDK:083N8182	FDK:083N8183	FDK:083N8178	FDK:083N8180
24"	FDK:083N8190	FDK:083N8191	A5E32709738	A5E32710253

For use as protection ring order 2 pcs.
For use as grounding ring order 1 pc.

AS2129, Table E	
DN	Article No.
DN 15 DN 25 DN 40	FDK:083N8365 FDK:083N8272 FDK:083N8280
DN 50 DN 65 DN 80	FDK:083N8281 FDK:083N8284 FDK:083N8293
DN 100 DN 125 DN 150	FDK:083N8117 FDK:083N8121 FDK:083N8128
DN 200 DN 250 DN 300	FDK:083N8134 FDK:083N8143 FDK:083N8151
DN 350 DN 400 DN 450	FDK:083N8153 FDK:083N8161 FDK:083N8176
DN 500 DN 600	FDK:083N8185 A5E32710253

For use as protection ring order 2 pcs.
For use as grounding ring order 1 pc.

Accessories for MAG 3100 and MAG 3100 HT sensor**Grounding and protecting ring - Type E (Hastelloy)**

Material: Hastelloy C276
For all PTFE liners
1 pc. incl. straps and screws

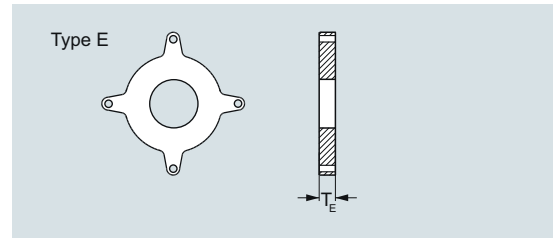

DN	PN 6	PN 16	PN 40	Size	ANSI Class 150	Class 300
	Article No.	Article No.	Article No.		Article No.	Article No.
DN 15			FDK:083N8487	1/2"	FDK:083N8487	FDK:083N8487
DN 25			FDK:083N8488	1"	FDK:083N8489	FDK:083N8489
DN 40			FDK:083N8490	1 1/2"	FDK:083N8491	FDK:083N8491
DN 50			FDK:083N8492	2"	FDK:083N8493	FDK:083N8493
DN 65	FDK:083N8494	FDK:083N8495	FDK:083N8496	2 1/2"	FDK:083N8497	FDK:083N8497
DN 80	FDK:083N8498	FDK:083N8499	FDK:083N8500	3"	FDK:083N8501	FDK:083N8502
DN 100	FDK:083N8503	FDK:083N8504	FDK:083N8505	4"	FDK:083N8506	FDK:083N8507

Accessories for MAG 3100 and MAG 3100 HT sensor**Grounding ring - Type Flat ring (Stainless steel)¹⁾**

Material: AISI 316
For all liners (PTFE max. 130 °C (266 °F))
1 pc. incl. straps and screws

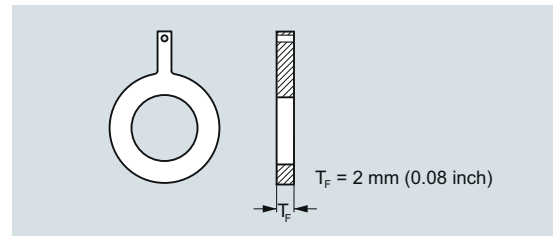

DN	PN 10	PN 16	PN 40	Size	ANSI Class 150	Class 300
	Article No.	Article No.	Article No.		Article No.	Article No.
DN 15			A5E01191969	1/2"	A5E01191968	
DN 25			A5E01150880	1"	A5E01150022	A5E01150378
DN 40			A5E01191952	1 1/2"	A5E01191961	
DN 50		A5E01192006	A5E01150918	2"	A5E01151121	A5E01151194
DN 65		A5E01191940	A5E01191954	2 1/2"	A5E01191962	
DN 80		A5E01152876	A5E01152876	3"	A5E01152910	A5E01153422
DN 100		A5E01158875	A5E01159072	4"	A5E01159146	A5E01159628
DN 125		A5E01191941	A5E01191956	5"	A5E01191963	
DN 150		A5E01191943	A5E01191957	6"	A5E01191964	
DN 200	A5E01191951	A5E01191944	A5E01191958	8"	A5E01191965	
DN 250	A5E01191950	A5E01191946	A5E01191959	10"	A5E01191966	
DN 300	A5E01191949	A5E01191947	A5E01191960	12"	A5E01191967	

¹⁾ Also for MAG 5100 W (7ME6580)

Flow Measurement

SITRANS F M

Flow sensor MAG 3100 and MAG 3100 HT

Accessories for MAG 3100 and MAG 3100 HT sensor

Grounding ring - Type Flat ring (Hastelloy)

Material: Hastelloy C276
 For all liners (PTFE max. 130 °C (266 °F))
 1 pc. incl. straps and screws

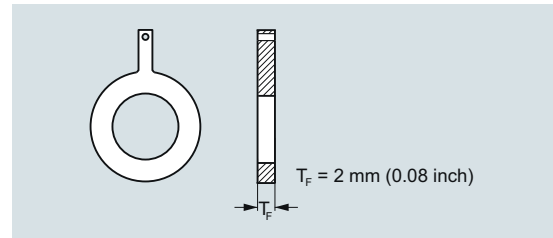

DN	PN 10 Article No.	PN 16 Article No.	PN 40 Article No.	Size	ANSI Class 150 Article No.	Class 300 Article No.
DN 15			A5E01191981	1/2"	A5E01191989	
DN 25			A5E01150882	1"	A5E01150028	A5E01150379
DN 40			A5E01191982	1 1/2"	A5E01191990	
DN 50			A5E01150922	2"	A5E01151124	A5E01151197
DN 65		A5E01191971	A5E01191983	2 1/2"	A5E01191991	
DN 80		A5E01152889	A5E01152889	3"	A5E01152913	A5E01153424
DN 100		A5E01158886	A5E01159074	4"	A5E01159150	A5E01159629
DN 125		A5E01191973	A5E01191984	5"	A5E01191992	
DN 150		A5E01191974	A5E01191985	6"	A5E01191993	
DN 200	A5E01191978	A5E01191975	A5E01191986	8"	A5E01191994	
DN 250	A5E01191979	A5E01191976	A5E01191987	10"	A5E01191995	
DN 300	A5E01191980	A5E01191977	A5E01191988	12"	A5E01191996	

Accessories for MAG 3100 and MAG 3100 HT sensor

Grounding ring - Type Flat ring (Tantalum)

Material: Tantalum
 For all liners (PTFE max. 130 °C (266 °F))
 1 pc. incl. straps and screws

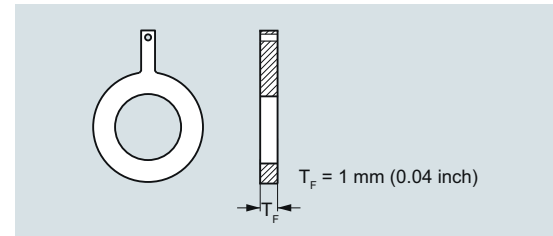

DN	PN 16 Article No.	PN 40 Article No.	Size	ANSI Class 150 Article No.	Class 300 Article No.
DN 15		A5E01192007	1/2"	A5E01192010	
DN 25		A5E01150883	1"	A5E01150030	A5E01150381
DN 40		A5E01192008	1 1/2"	A5E01192011	
DN 50		A5E01150926	2"	A5E01151129	A5E01151199
DN 65	A5E01192005	A5E01192009	2 1/2"	A5E01192012	
DN 80	A5E01152890	A5E01152890	3"	A5E01152916	A5E01153427
DN 100	A5E01158891	A5E01159076	4"	A5E01159156	A5E01159631

Dimensional drawings

MAG 3100 and MAG 3100 HT sensor with compact or remote transmitter

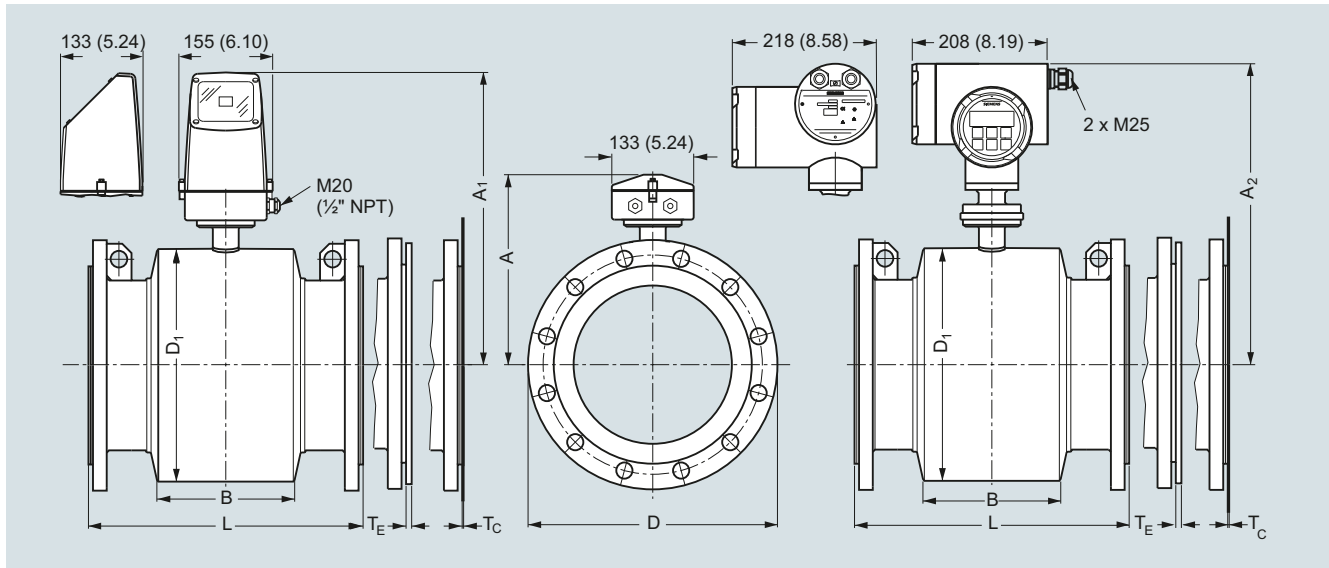

Dimensions in mm (inch)

Metric

DN	A ¹⁾	A ₁	A ₂	B	D ₁	L ^{2) 3)}						ANSI 16.5	
						EN 1092-1-201		PN 25	PN 40	PN 63	PN 100	Class 150	Class 300
[mm]	[mm]	[mm]	[mm]	[mm]	[mm]	[mm]	[mm]					[mm]	[mm]
15	187	341	338	59	104	-	-	-	200	-	-	200	200
25	187	341	338	59	104	-	-	-	200	-	260	200	200
40	197	351	348	82	124	-	-	-	200	-	280	200	200
50	205	359	356	72	139	-	-	-	200	276	300	200	200
65	212	366	363	72	154	200	200/-	-	200	320	350	200	272
80	222	376	373	72	174	200	200/-	-	272 ⁴⁾	323	340	272 ⁴⁾	272 ⁴⁾
100	242	396	393	85	214	250	250/-	-	250	380	400	250	310
125	255	409	406	85	239	250	250/-	-	250	420	450	250	335
150	276	430	427	85	282	300	300/-	-	300	415	450	300	300
200	304	458	455	137	338	350	350/-	350	350	480	530	350	350
250	332	486	483	157	393	450	450/-	450	450	550	620	450	450
300	357	511	508	157	444	500	500/-	500	500	600	680	500	500
350	362	516	513	270	451	550	550/-	550	550	-	-	550	550
400	387	541	538	270	502	600	600/-	600	600	-	-	600	600
450	418	572	569	310	563	600	600/-	600	600	-	-	600	640
500	443	597	594	350	614	600	600/-	625	680	-	-	600	730
600	494	648	645	320	715	600	600/-	750	800	-	-	600	860
700	544	698	695	450	816	700	875/700	800	-	-	-	800	-
750	571	725	722	556	869	-	-/-	-	-	-	-	950	-
800	606	760	757	560	927	800	1000/800	900	-	-	-	900	-
900	653	807	804	630	1032	900	1125/900	1000	-	-	-	1100	-
1000	704	858	855	670	1136	1000	1250/1000	1100	-	-	-	1100	-
1050	704	858	855	670	1136	-	-/-	-	-	-	-	-	-
1100	755	904	901	770	1238	-	-/-	-	-	-	-	-	-
1200	810	964	961	792	1348	1200	1500/1200	1300	-	-	-	1400	-
1400	925	1079	1076	1000	1574	1400	-/1400	-	-	-	-	-	-
1500	972	1126	1123	1020	1672	1500	-/1500	-	-	-	-	-	-
1600	1025	1179	1176	1130	1774	1600	-/1600	-	-	-	-	-	-
1800	1123	1277	1274	1250	1974	1800	-/1800	-	-	-	-	-	-
2000	1223	1377	1374	1375	2174	2000	-/2000	-	-	-	-	-	-

¹⁾ 14.5 mm shorter with stainless steel terminal box (Ex and high temperature version)

²⁾ When grounding rings are used, the thickness of the grounding ring must be added to the built-in length

³⁾ Tolerances on built-in length (PN 6, PN 10, PN 16, PN 25 and PN 40):

DN 15 to DN 200: +0/-3 mm, DN 250 to DN 400: +0/-5 mm, DN 450 to DN 600: +5/-5 mm, DN 700 to DN 2000: +10/-10 mm

Tolerances on built in length (PN 63 and PN 100): All sizes: +8/-8 mm

⁴⁾ Not according to ISO 13359

Flow Measurement

SITRANS F M

Flow sensor MAG 3100 and MAG 3100 HT

DN	L ^{1) 2)}				T _C ³⁾	T _E ³⁾	T _F ³⁾	Weight ⁴⁾
	AS 2129 E AS 4087 PN 16, 21, 35	AWWA C-207 Class D	JIS K10	JIS K20				
[mm]	[mm]	[mm]	[mm]	[mm]	[mm]	[mm]	[mm]	[kg]
15	200	-	200	200	-	6	2	4
25	200	-	200	200	1.2	6	2	5
40	200	-	200	240	1.2	6	2	8
50	200	-	200	240	1.2	6	2	9
65	200	-	200	272	1.2	6	2	11
80	200 ⁵⁾	-	200 ⁹⁾	272 ⁹⁾	1.2	6	2	12
100	250	-	250	310	1.2	6	2	16
125	250	-	250	335	1.2	6	2	19
150	300	-	300	300	1.2	6	2	27
200	350	-	350	350	1.2	8	2	40
250	450	-	450	450	1.2	8	2	60
300	500	-	500	500	1.6	8	2	80
350	550	-	550	550	1.6	8	-	110
400	600	-	600	600	1.6	10	-	125
450	600	-	600	640	1.6	10	-	175
500	600 ⁶⁾	-	600	680	1.6	10	-	200
600	600 ⁷⁾	-	600	800	1.6	10	-	287
700	700 ⁸⁾	700	-	-	2.0	-	-	330
750	750 ⁸⁾	750	-	-	2.0	-	-	360
800	800 ⁸⁾	800	-	-	2.0	-	-	450
900	900 ⁸⁾	900	-	-	2.0	-	-	530
1000	1000 ⁸⁾	1000	-	-	2.0	-	-	660
1050	-	1050	-	-	2.0	-	-	660
1100	-	1100	-	-	2.0	-	-	1140
1200	1200 ⁶⁾	1200	-	-	2.0	-	-	1180
1400	-	1400	-	-	2.0	-	-	1600
1500	-	1500	-	-	3.0	-	-	2460
1600	-	1600	-	-	3.0	-	-	2525
1800	-	1800	-	-	3.0	-	-	2930
2000	-	2000	-	-	3.0	-	-	3665

1) When grounding rings are used, the thickness of the grounding ring must be added to the built-in length

2) Tolerances on built-in length (PN 6, PN 10, PN 16, PN 25 and PN 40):

DN 15 to DN 200: +0/-3 mm, DN 250 to DN 400 : +0/-5 mm, DN 450 to DN 600 : +5/-5 mm, DN 700 to DN 2000 : +10/-10 mm

Tolerances on built-in length (PN 63 and PN 100):

All sizes: +8/-8 mm

3) T_C = Protection ring Type C, T_E = Grounding ring Type E (included and factory mounted for 180 °C PTFE liner), T_F = Grounding ring Type Flat ring

4) Weights are approx. (for PN 16) without transmitter

5) PN 35 DN 80 = 272 mm (not according to ISO 13359)

6) PN 35 DN 500 = 680 mm

7) PN 35 DN 600 = 750 mm

8) Not AS 4087 PN 21 or PN 35

9) Not according to ISO 13359

D = Outside diameter of flange, see flange tables

MAG 3100 and MAG 3100 HT sensor with compact or remote transmitter

Imperial

Size	A ¹⁾	A ₁	A ₂	B	D ₁	L ^{2) 3)}								
						EN 1092-1-201						ANSI 16.5/ASME B16.47 ⁴⁾		
						PN 6, 10	PN 16/ PN 16 non PED	PN 25	PN 40	PN 63	PN 100	Class 150	Class 300	Class 600
[inch]	[inch]	[inch]	[inch]	[inch]	[inch]	[inch]	[inch]	[inch]	[inch]	[inch]	[inch]	[inch]		
½	7.36	13.31	13.25	2.32	4.09	-	-	-	7.87	-	-	7.87	7.87	-
1	7.36	13.31	13.25	2.32	4.09	-	-	-	7.87	-	10.24	7.87	7.87	11.02
1½	7.76	13.70	13.64	3.23	4.88	-	-	-	7.87	-	11.02	7.87	7.87	12.60
2	8.07	14.01	13.95	2.83	5.47	-	-	-	7.87	10.87	11.81	7.87	7.87	12.99
2½	8.35	14.29	14.23	2.83	6.06	7.87	7.87/-	-	7.87	12.60	13.78	7.87	10.71	on request
3	8.74	14.69	14.63	2.83	6.85	7.87	7.87/-	-	10.71 ⁵⁾	12.72	13.39	10.71 ⁵⁾	10.71 ⁵⁾	13.78
4	9.53	15.47	15.41	3.35	8.43	9.84	9.84/-	-	9.84	14.96	-	9.84	12.20	18.11
5	10.04	15.98	15.92	3.35	9.41	9.84	9.84/-	-	9.84	16.54	-	9.84	13.10	18.90
6	10.87	16.81	16.75	5.39	11.10	11.81	11.81/-	-	11.81	16.34	-	11.81	11.81	19.68
8	11.97	17.91	17.85	5.39	13.31	13.78	13.78/-	13.78	13.78	18.90	-	13.78	13.78	23.62
10	13.07	19.02	18.96	6.18	15.47	17.72	17.72/-	17.72	17.72	-	-	17.72	17.72	23.62
12	14.05	20.00	19.94	6.18	17.48	19.69	19.69/-	19.69	19.69	-	-	19.69	19.69	27.56
14	14.25	20.20	20.14	10.63	17.76	21.65	21.65/-	21.65	21.65	-	-	21.65	21.65	-
16	15.24	21.18	21.12	10.63	19.76	23.62	23.62/-	23.62	23.62	-	-	23.62	23.62	-
18	16.45	22.40	22.34	12.20	22.16	23.62	23.62/-	23.62	23.62	-	-	23.62	23.62	-
20	17.44	23.39	23.33	13.78	24.17	23.62	23.62/-	24.61	26.77	-	-	23.62	28.70	-
24	19.45	25.39	25.33	12.59	28.15	23.62	23.62/-	29.53	31.50	-	-	23.62	33.80	-
28	21.42	27.36	27.30	17.72	32.13	27.56	34.45/27.56	31.50	-	-	-	31.50	-	-
30	22.48	28.43	28.37	21.89	34.21	-	-	-	-	-	-	37.41	-	-
32	23.86	29.80	29.74	22.05	36.50	31.50	39.37/31.50	35.44	-	-	-	35.44	-	-
36	25.71	31.65	31.59	24.80	40.63	35.43	44.29/35.43	39.38	-	-	-	43.32	-	-
40	27.72	33.85	33.79	26.38	44.72	39.37	49.21/39.37	43.32	-	-	-	43.32	-	-
42	27.72	33.85	33.79	26.38	44.72	-	-	-	-	-	-	-	-	-
44	29.72	35.67	35.61	30.31	48.74	-	-	-	-	-	-	-	-	-
48	31.89	37.83	37.77	31.18	53.07	47.24	59.06/47.24	51.19	-	-	-	55.12	-	-
54	36.42	42.36	42.30	39.37	61.97	55.12	-/55.12	-	-	-	-	-	-	-
60	38.27	44.21	44.15	40.15	65.83	59.06	59.06/59.06	-	-	-	-	-	-	-
66	40.35	46.30	46.24	44.49	69.84	62.99	-/62.99	-	-	-	-	-	-	-
72	44.21	50.16	50.10	49.21	77.72	70.87	-/70.87	-	-	-	-	-	-	-
78	48.15	54.09	54.03	54.13	85.59	78.74	-/78.74	-	-	-	-	-	-	-

1) 0.571 inch shorter with stainless steel terminal box (Ex and high temperature version)

2) When grounding rings are used, the thickness of the grounding ring must be added to the built-in length

3) Tolerances on built-in length (PN 6, PN 10, PN 16, PN 25 and PN 40):

½" to 8": +0/-0.12", 10" to DN 16": +0/-0.20", 18" to DN 24": +0.20/-0.20", 28" to DN 78": +0.39/-0.39"

Tolerances on built-in length (PN 63 and PN 100):

All sizes: +0.31/-0.31"

4) ANSI 16.5 for DN ≤ 24"; ASME B16.47 for DN ≥ 28"

5) Not according to ISO 13359

Flow Measurement

SITRANS F M

Flow sensor MAG 3100 and MAG 3100 HT

Size	L ^{1) 2)}				T _C ³⁾	T _E ³⁾	T _F ³⁾	Weight ⁴⁾
	AS 2129 E AS 4087 PN 16, 21, 35	AWWA C-207 Class D	JIS K10	JIS K20				
[in.]	[inch]	[inch]	[inch]	[inch]	[inch]	[inch]	[inch]	[lb]
½	7.87	-	7.87	7.87	-	0.24	0.08	9
1	7.87	-	7.87	7.87	0.05	0.24	0.08	11
1½	7.87	-	7.87	9.44	0.05	0.24	0.08	17
2	7.87	-	7.87	9.44	0.05	0.24	0.08	20
2½	7.87	-	7.87	10.70	0.05	0.24	0.08	24
3	7.87 ⁵⁾	-	7.87 ⁸⁾	10.70 ⁹⁾	0.05	0.24	0.08	26
4	9.84	-	9.84	12.20	0.05	0.24	0.08	35
5	9.84	-	9.84	13.18	0.05	0.24	0.08	42
6	11.81	-	11.81	11.81	0.05	0.24	0.08	60
8	13.78	-	13.77	13.77	0.05	0.31	0.08	88
10	17.72	-	17.71	17.71	0.05	0.31	0.08	132
12	19.69	-	19.68	19.68	0.06	0.31	0.08	176
14	21.65	-	21.65	21.65	0.06	0.31	-	242
16	23.62	-	23.62	23.62	0.06	0.39	-	275
18	23.62	-	23.62	25.19	0.06	0.39	-	385
20	23.62 ⁶⁾	-	23.62	26.77	0.06	0.39	-	440
24	23.62 ⁷⁾	-	23.62	31.49	0.06	0.39	-	633
28	27.56 ⁸⁾	27.56	-	-	0.08	-	-	728
30	29.53 ⁸⁾	29.52	-	-	0.08	-	-	794
32	31.50 ⁸⁾	31.50	-	-	0.08	-	-	992
36	35.43 ⁸⁾	35.43	-	-	0.08	-	-	1168
40	39.37 ⁸⁾	39.37	-	-	0.08	-	-	1455
42	-	39.37	-	-	0.08	-	-	1455
44	-	43.31	-	-	0.08	-	-	2513
48	47.24 ⁸⁾	47.24	-	-	0.08	-	-	2601
54	-	55.12	-	-	0.12	-	-	3528
60	-	59.06	-	-	0.12	-	-	5423
66	-	63.00	-	-	0.12	-	-	5566
72	-	70.87	-	-	0.12	-	-	6460
78	-	78.74	-	-	0.12	-	-	8080

1) When grounding rings are used, the thickness of the grounding ring must be added to the built-in length

2) Tolerances on built-in length (PN 6, PN 10, PN 16, PN 25 and PN 40):

½" to 8": +0/-0.12", 10" to DN 16": +0/-0.20", 18" to DN 24": +0.20/-0.20", 28" to DN 78": +0.39/-0.39"

Tolerances on built-in length (PN 63 and PN 100):

All sizes: +0.31/-0.31"

3) T_C = Protection ring Type C, T_E = Grounding ring Type E (included and factory mounted for 356 °F PTFE liner), T_F = Grounding ring Type Flat ring

4) Weights are for ANSI 150 without transmitter

5) PN 35 DN 80 = 10.70 inch

6) PN 35 DN 500 = 26.77 inch

7) PN 35 DN 600 = 29.53 inch

8) Not AS 4087 PN 21 or PN 35

9) Not according to ISO 13359

D = Outside diameter of flange, see flange tables

Overview

The SITRANS F M MAG 3100 P is designed to meet the most common specifications within chemical and process industries.

Benefits

- DN 15 to DN 300 (½" to 12")
- Included in Quick Ship Program (delivery time see PIA LCP)
- Most used flowmeter in the chemical and process industries with PTFE/PFA liner and Hastelloy electrodes
- Excellent chemical resistance
- Full scope of global approvals for hazardous areas:
 - ATEX, FM, CSA, IECEx
 - 24 V and 115/230 V Ex compact and remote
 - intrinsically safe ia analog output
- Comprehensive self-diagnostic for error indication and error logging
- Fully welded construction provides a ruggedness that suits the toughest applications and environments
- Easy commissioning, the SENSORPROM unit automatically updates settings.
- MAG 6000 I full NAMUR compliance
 - compliant with NE 21, NE 32, NE 43, NE 53 and NE 70

Application

The main applications of the SITRANS F M electromagnetic flow sensors can be found in the following fields:

- Chemical industry
- Process industry
- Pulp and paper
- Industrial waste water

Design

- Compact or remote mounting possible
- Easy "plug & play" field changeability of transmitter
- High temperature sensor for applications with temperatures up to 150 °C (302 °F)
- Meets EEC directives: PED, 2014/68/EU pressure directive for EN1092-1 flanges
- Built-in length according to ISO 13359
- Onsite or factory upgrade to IP68/NEMA 6P of a standard sensor.

Mode of operation

The flow measuring principle is based on Faraday's law of electromagnetic induction according to which the sensor converts the flow into an electrical voltage proportional to the velocity of the flow.

Integration

The complete flowmeter consists of a flow sensor and an associated transmitter MAG 5000, 6000 and 6000 I.

The flexible communication concept USM II simplifies integration and update to a variety of fieldbus systems such as HART, FOUNDATION Fieldbus H1, DeviceNet, PROFIBUS DP and PA, Modbus RTU/RS 485.

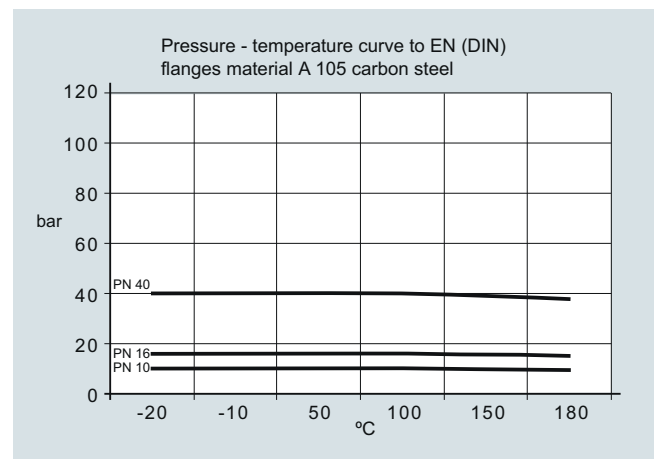
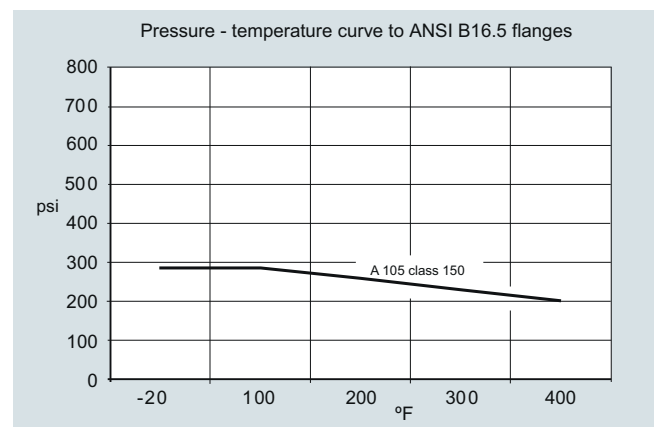
Pressure/temperature curve to EN (DIN) flanges, material A 105 carbon steel**Pressure/temperature curve to ANSI B16.5 flanges**

Note: The pressure-temperature curves only assist in the selection of a system. No responsibility is taken for the correctness of the information. For further information on the PED standard and requirements, see page 10/15.

Flow Measurement

SITRANS F M

Flow sensor MAG 3100 P

Technical specifications

Product characteristic	Chemical and process industry-oriented (Included in Quick Ship Program)	Design	
Nominal size	<ul style="list-style-type: none"> • PTFE: DN 15 ... 300 (½" ... 12") • PFA: DN 15 ... 150 (½" ... 6") 	Weight	See dimensional drawings
Measuring principle	Electromagnetic induction	Flange and housing material	Carbon steel ASTM A 105, with corrosion resistant coating Corrosivity category C4, according to ISO 12944-2
Excitation frequency (Mains supply: 50 Hz/60 Hz)	<ul style="list-style-type: none"> • DN 15 ... 65 (½" ... 2½"): 12.5 Hz/15 Hz • DN 80 ... 150 (3" ... 6"): 6.25 Hz/7.5 Hz • DN 200 ... 300 (8" ... 12"): 3.125 Hz/3.75 Hz 	Electrode material	PTFE: Hastelloy C276/2.4819 PFA: Hastelloy C22/2.4602
Process connection		Grounding electrode material	PTFE: No grounding electrodes PFA: Hastelloy
Flanges	EN 1092-1, raised face ¹⁾ (EN 1092-1, DIN 2501 and BS 4504 have the same mating dimensions) <ul style="list-style-type: none"> • DN 15 ... 50 (½" ... 2"): PN 40 (580 psi) • DN 65 ... 300 (2½" ... 12"): PN 16 (232 psi) • DN 200 ... 300 (8" ... 12"): PN 10 (145 psi) ANSI B16.5 (~BS 1560), raised face <ul style="list-style-type: none"> • ½" ... 12": Class 150 (20 bar (290 psi)) 	Terminal box (remote version only)	<ul style="list-style-type: none"> • Standard fibre glass reinforced polyamide • Option Stainless steel AISI 316/1.4436 • Ex sensor: Stainless steel AISI 316/1.4436
Rated operation conditions		Cable entries	<ul style="list-style-type: none"> • Remote installation 2 x M20 or 2 x ½" NPT • Compact installation <ul style="list-style-type: none"> - MAG 5000/MAG 6000: 4 x M20 or 4 x ½" NPT - MAG 6000 I: 2 x M25 or 2 x ½" NPT (for supply/output) - MAG 6000 I Ex: 2 x M25 or 2 x ½" NPT (for supply/output)
Ambient temperature (conditions also dependent on liner characteristics)		Certificates and approvals	
<ul style="list-style-type: none"> • Standard sensor • Ex sensor • Compact with transmitter <ul style="list-style-type: none"> - MAG 5000/6000 - MAG 6000 I - MAG 6000 I Ex 	-40 ... +100 °C (-40 ... +212 °F) -20 ... +60 °C (-4 ... +140 °F) -20 ... +60 °C (-4 ... +140 °F) -20 ... +60 °C (-4 ... +140 °F) -20 ... +60 °C (-4 ... +140 °F)	Calibration	
Operating pressure [abs. bar] (maximum operating pressure decreases with increasing operating temperature and with stainless steel flanges)	<ul style="list-style-type: none"> • PTFE Teflon <ul style="list-style-type: none"> - DN 15 ... 300 (½" ... 12"): 0.3 ... 40 bar (4 ... 580 psi) • PFA <ul style="list-style-type: none"> - DN 15 ... 150 (½" ... 6"): Vacuum 0.02 ... 50 bar (0.29 ... 725 psi) 	Standard production calibration	Zero-point, 2 x 25 % and 2 x 90 %
Enclosure rating	IP67 to EN 60529/NEMA 4X/6, 1 mH ₂ O for 30 min Option: IP68 to EN 60529/NEMA 6P, 10 mH ₂ O cont. (not for Ex)	Hazardous area	
Pressure drop at 3 m/s	As straight pipe	Ex-sensor in compact or remote version with MAG 6000 I Ex	<ul style="list-style-type: none"> • ATEX, FM, CSA, IECEx, EAC Ex, NEPSI <ul style="list-style-type: none"> - Zone 1 Ex de ia IIC T6 Gb • ATEX, FM, CSA, IECEx, EAC Ex <ul style="list-style-type: none"> - Zone 21 Ex tD A21 IP67 • FM <ul style="list-style-type: none"> - XP IS Class I Div. 1 Groups A, B, C, D²⁾ - DIP Class II+III Div. 1 Groups E, F, G²⁾ • FM <ul style="list-style-type: none"> - NI Class I Div. 2 Groups A, B, C, D - NI Class I Div. 2 Groups IIC
Test pressure	1.5 x PN (where applicable)	Ex-sensor with/without MAG 5000/6000/6000 I	
Mechanical load (vibration)	<ul style="list-style-type: none"> • 18 ... 1000 Hz random in x, y, z, directions for 2 hours according to EN 60068-2-36 • Sensor: 3.17 g RMS • Sensor with compact MAG 5000/6000 mounted transmitter: 3.17 g RMS • Sensor with compact MAG 6000 I/6000 I Ex mounted transmitter: 1.14 g RMS 	Pressure equipment	PED, CRN
Temperature of medium	<ul style="list-style-type: none"> • PTFE -20 ... +150 °C (-4 ... +302 °F) • PFA -20 ... +150 °C (-4 ... +302 °F) 	Others	EAC (Russia, Belarus, Kazakhstan) KCC (South Korea)
EMC	2014/30/EU		

¹⁾ DN ≤ 600 type 01 (SORF); DN > 600 type 11 (WNRFF)

²⁾ In compact version only

Selection and Ordering data	Article No.
Sensor SITRANS F M MAG 3100 P (Short delivery time)	7ME6340-
Click on the Article No. for the online configuration in the PIA Life Cycle Portal.	
Diameter	
DN 15 (1/2")	1 V
DN 25 (1")	2 D
DN 40 (1 1/2")	2 R
DN 50 (2")	2 Y
DN 65 (2 1/2")	3 F
DN 80 (3")	3 M
DN 100 (4")	3 T
DN 125 (5")	4 B
DN 150 (6")	4 H
DN 200 (8")	4 P
DN 250 (10")	4 V
DN 300 (12")	5 D
Flange norm and pressure rating	
EN 1092-1	
PN 10 (DN 200 ... 300 (8" ... 12"))	B
PN 16 (DN 65 ... 300 (2 1/2" ... 12"))	C
PN 40 (DN 15 ... 50 (1/2" ... 2"))	F
ANSI B16.5	
Class 150 (1/2" ... 12")	J
Flange material	
Carbon steel flanges ASTM A 105	1
Liner material	
PTFE (150 °C (302 °F))	3
PFA (150 °C (302 °F)) (DN 15 ... 150 (1/2" ... 6"))	7
Electrode material	
Hastelloy C	2
Hastelloy C incl. grounding electrodes (only PFA)	6
Transmitter	
Standard sensor for remote transmitter (Order transmitter separately)	A
Ex sensor for remote transmitter (Order transmitter separately)	B
MAG 6000 I, Aluminum, 18 ... 90 V DC, 115 ... 230 V AC	C
MAG 6000 I, Aluminum, 18 ... 30 V DC, Ex	D
MAG 6000 I, Aluminum, 115 ... 230 V AC, Ex	E
MAG 6000, Polyamide, 11 ... 30 V DC/11 ... 24 V AC	H
MAG 6000, Polyamide, 115 ... 230 V AC	J
MAG 5000, Polyamide, 11 ... 30 V DC/11 ... 24 V AC	K
MAG 5000, Polyamide, 115 ... 230 V AC	L
Communication	
No communication, add-on possible	A
HART	B
PROFIBUS PA Profile 3 (only MAG 6000/MAG 6000 I)	F
PROFIBUS DP Profile 3 (not for Ex) (only MAG 6000/MAG 6000 I)	G
Modbus RTU/RS 485 (not for Ex) (only MAG 6000/MAG 6000 I)	E
FOUNDATION Fieldbus H1 (only MAG 6000/6000 I)	J
Cable glands/terminal box	
Metric: Polyamide terminal box or MAG 6000 I compact	1
1/2" NPT: Polyamide terminal box or MAG 6000 I compact	2
Metric: Stainless steel terminal box	3
1/2" NPT: Stainless steel terminal box	4

Selection and Ordering data	Order code
Additional information	
Please add "-Z" to Article No. and specify Order code(s) and plain text.	
Certificates	
• Factory certificate according to EN 10204-2.2	C14
• Factory certificate according to EN 10204-2.1	C15
Terminal blocks	
• Factory mounted terminal blocks	N02
Region/customer specific labels	
• KCC label (South Korea)	W28
Tag name plate, stainless steel (specify in plain text)	Y17
Tag name plate, plastic (self adhesive)	Y18
Customer-specific transmitter setting	Y20
Sensor cable wired (specify Article No. for sensor cables and order cables separately)	Y40
Sensor cables wired and IP68 sealing (Article No. for sensor cables and order cables separately)	Y41
Special version (specify in plain text)	Y99
Additional calibrations	
• Matched pair - (Standard production calibration where sensor and transmitter is calibrated together)	On request¹⁾
• Accredited Siemens Flow Instruments matched pair Calibration acc. to ISO/IEC 17025: 2005	On request¹⁾
• Customer-specified calibration up to 10 points	On request¹⁾
• Customer-witnessed calibration Any of above calibration	On request¹⁾

¹⁾ Product Variation Request (PVR).

Operating instructions for SITRANS F M MAG 3100 P

Description	Article No.
• English	A5E03005599
• German	A5E03086288

All literature is available to download for free, in a range of languages, at www.siemens.com/processinstrumentation/documentation

Accessories

Description	Article No.
Potting kit for IP68/NEMA 6P sealing of sensor junction box	FDK:085U0220



Please use online Product selector to get latest updates.
Product selector link: www.pia-portal.automation.siemens.com

Flow Measurement

SITRANS F M

Flow sensor MAG 3100 P

Accessories for MAG 3100 P sensor

Grounding and protection ring - Type E (Stainless steel)

Material: AISI 316
For liner PTFE
1 pc. incl. straps and screws

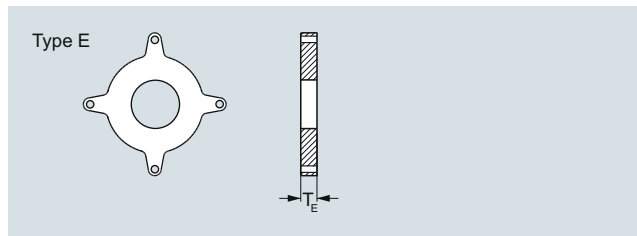

DN	PN 10 Article No.	PN 16 Article No.	PN 40 Article No.	ANSI ¹⁾	Class 150 Article No.
DN 15			FDK:083N8365	½"	FDK:083N8365
DN 25			FDK:083N8271	1"	FDK:083N8272
DN 40			FDK:083N8278	1½"	FDK:083N8279
DN 50		FDK:083N8285 FDK:083N8289	FDK:083N8282	2"	FDK:083N8283
DN 65				2½"	FDK:083N8287
DN 80				3"	FDK:083N8291
DN 100		FDK:083N8117 FDK:083N8121 FDK:083N8125		4"	FDK:083N8118
DN 125				5"	FDK:083N8122
DN 150				6"	FDK:083N8126
DN 200	FDK:083N8130	FDK:083N8130		8"	FDK:083N8370
DN 250	FDK:083N8136	FDK:083N8137		10"	FDK:083N8140
DN 300	FDK:083N8144	FDK:083N8145		12"	FDK:083N8148

For use as protection ring order 2 pcs.
For use as grounding ring order 1 pc.

Accessories for MAG 3100 P sensor

Grounding and protection ring - Type E (Hastelloy)

Material: Hastelloy C276
For liner PTFE
1 pc. incl. straps and screws

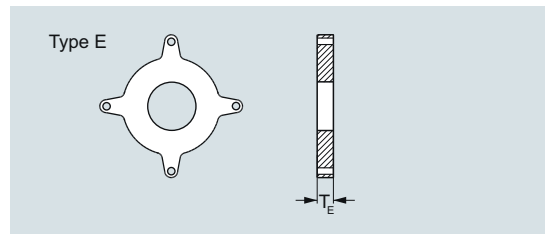

DN	PN 16 Article No.	PN 40 Article No.	Size	ANSI ¹⁾ Class 150 Article No.
DN 15		FDK:083N8487	½"	FDK:083N8487
DN 25		FDK:083N8488	1"	FDK:083N8489
DN 40		FDK:083N8490	1½"	FDK:083N8491
DN 50		FDK:083N8492	2"	FDK:083N8493
DN 65	FDK:083N8495		2½"	FDK:083N8497
DN 80	FDK:083N8499		3"	FDK:083N8501
DN 100	FDK:083N8504		4"	FDK:083N8506

¹⁾ For dimensions of MAG 3100 P see table on page 3/88

Accessories for MAG 3100 P sensor**Grounding ring - Type Flat ring (Stainless steel)**

Material: AISI 316
For liner PTFE and PFA
1 pc. incl. straps and screws

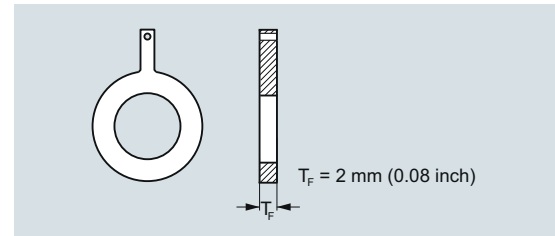

DN	PN 10 Article No.	PN 16 Article No.	PN 40 Article No.	Size	ANSI ¹⁾ Class 150 Article No.
DN 15			A5E01191968	1/2"	A5E01191969
DN 25			A5E01150880	1"	A5E01150022
DN 40			A5E01191952	1 1/2"	A5E01191961
DN 50			A5E01150918	2"	A5E01151121
DN 65		A5E01191940		2 1/2"	A5E01191962
DN 80		A5E01152876		3"	A5E01152910
DN 100		A5E01158875		4"	A5E01159146
DN 125		A5E01191941		5"	A5E01191963
DN 150		A5E01191943		6"	A5E01191964
DN 200	A5E01191951	A5E01191944		8"	A5E01191965
DN 250	A5E01191950	A5E01191946		10"	A5E01191966
DN 300	A5E01191949	A5E01191947		12"	A5E01191967

Accessories for MAG 3100 P sensor**Grounding ring - Type Flat ring (Hastelloy)**

Material: Hastelloy C276
For liner PTFE and PFA
1 pc. incl. straps and screws

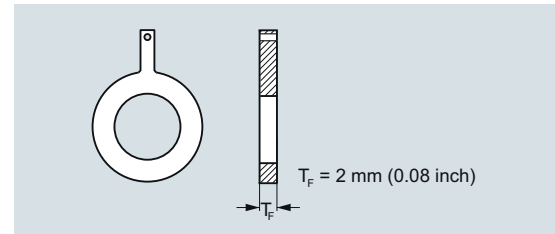

DN	PN 10 Article No.	PN 16 Article No.	PN 40 Article No.	Size	ANSI ¹⁾ Class 150 Article No.
DN 15			A5E01191981	1/2"	A5E01191989
DN 25			A5E01150882	1"	A5E01150028
DN 40			A5E01191982	1 1/2"	A5E01191990
DN 50			A5E01150922	2"	A5E01151124
DN 65		A5E01191971		2 1/2"	A5E01191991
DN 80		A5E01152889		3"	A5E01152913
DN 100		A5E01158886		4"	A5E01159150
DN 125		A5E01191973		5"	A5E01191992
DN 150		A5E01191974		6"	A5E01191993
DN 200	A5E01191978	A5E01191975		8"	A5E01191994
DN 250	A5E01191979	A5E01191976		10"	A5E01191995
DN 300	A5E01191980	A5E01191977		12"	A5E01191996

¹⁾ For dimensions of MAG 3100 P see table on page 3/88

Flow Measurement

SITRANS F M

Flow sensor MAG 3100 P

Dimensional drawings

MAG 3100 P sensor with compact or remote transmitter

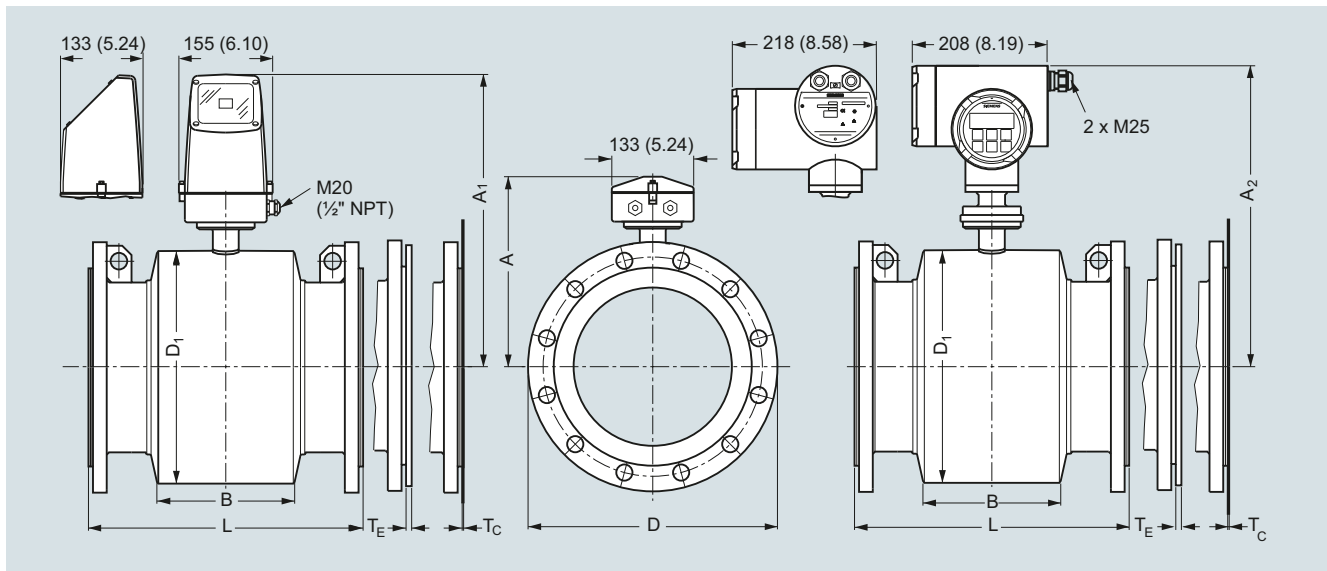

Dimensions in mm (inch)

Metric

DN	A ¹⁾	A ₁	A ₂	B	D ₁	L ²⁾				T _E ³⁾	T _F ³⁾	Weight ⁴⁾
						EN 1092-1-201 PN 10 [mm]	PN 16 [mm]	PN 40 [mm]	ANSI 16.5 Class 150 [mm]			
15	187	341	338	59	104	-	-	200	200	6	2	4
25	187	341	338	59	104	-	-	200	200	6	2	5
40	197	351	348	82	124	-	-	200	200	6	2	8
50	205	359	356	72	139	-	-	200	200	6	2	9
65	212	369	366	72	154	-	200/-	-	200	6	2	11
80	222	376	373	72	174	-	200/-	-	272 ⁵⁾	6	2	12
100	242	396	393	85	214	-	250/-	-	250	6	2	16
125	255	409	406	85	239	-	250/-	-	250	6	2	19
150	276	430	427	85	282	-	300/-	-	300	6	2	27
200	304	458	455	137	338	350	350/-	-	350	8	2	40
250	332	486	483	157	393	450	450/-	-	450	8	2	60
300	357	511	508	157	444	500	500/-	-	500	8	2	80

¹⁾ 14.5 mm shorter with stainless steel terminal box (Ex and high temperature version)

²⁾ When grounding rings are used, the thickness of the grounding ring must be added to the built-in length

³⁾ T_E = Grounding ring Type E, T_F = Grounding ring Type Flat ring

⁴⁾ Weights are approx. (for PN 16) without transmitter

⁵⁾ Not according to ISO 13359

D = Outside diameter of flange, see flange tables

MAG 3100 P sensor with compact or remote transmitter

Imperial

Size	A ¹⁾	A ₁	A ₂	B	D ₁	L ²⁾				T _E ³⁾	T _F ³⁾	Weight ⁴⁾
						EN 1092-1-201 PN 10	PN 16	PN 40	ANSI 16.5 Class 150			
[inch]	[inch]	[inch]	[inch]	[inch]	[inch]	[inch]	[inch]	[inch]	[inch]	[inch]	[inch]	[lb]
½	7.36	13.4	13.34	2.32	4.09	-	-	7.87	7.87	0.24	0.08	9
1	7.36	13.4	13.34	2.32	4.09	-	-	7.87	7.87	0.24	0.08	11
1½	7.76	13.8	13.74	3.23	4.88	-	-	7.87	7.87	0.24	0.08	17
2	8.07	14.1	14.04	2.83	5.47	-	-	7.87	7.87	0.24	0.08	20
2½	8.35	14.4	14.34	2.83	6.06	-	7.87/-	-	7.87	0.24	0.08	24
3	8.74	14.8	14.74	2.83	6.85	-	7.87/-	-	10.71 ⁵⁾	0.24	0.08	26
4	9.53	15.6	15.54	3.35	8.43	-	9.84/-	-	9.84	0.24	0.08	35
5	10.04	16.1	16.04	3.35	9.41	-	9.84/-	-	9.84	0.24	0.08	42
6	10.87	16.9	16.84	3.35	11.10	-	11.81/-	-	11.81	0.24	0.08	60
8	11.97	18.0	17.94	5.39	13.31	13.78	13.78/-	-	13.78	0.31	0.08	88
10	13.07	19.1	19.04	6.18	15.47	17.72	17.72/-	-	17.72	0.31	0.08	132
12	14.05	20.1	20.04	6.18	17.48	19.69	19.69/-	-	19.69	0.31	0.08	176

¹⁾ 0.571 inch shorter with stainless steel terminal box (Ex and high temperature version)

²⁾ When grounding rings are used, the thickness of the grounding ring must be added to the built-in length

³⁾ T_E = Grounding ring Type E, T_F = Grounding ring Type Flat ring

⁴⁾ Weights are for ANSI 150 without transmitter

⁵⁾ Not according to ISO 13359

D = Outside diameter of flange, see flange tables